

BALCONY/RAIL BRACKETS

RL001

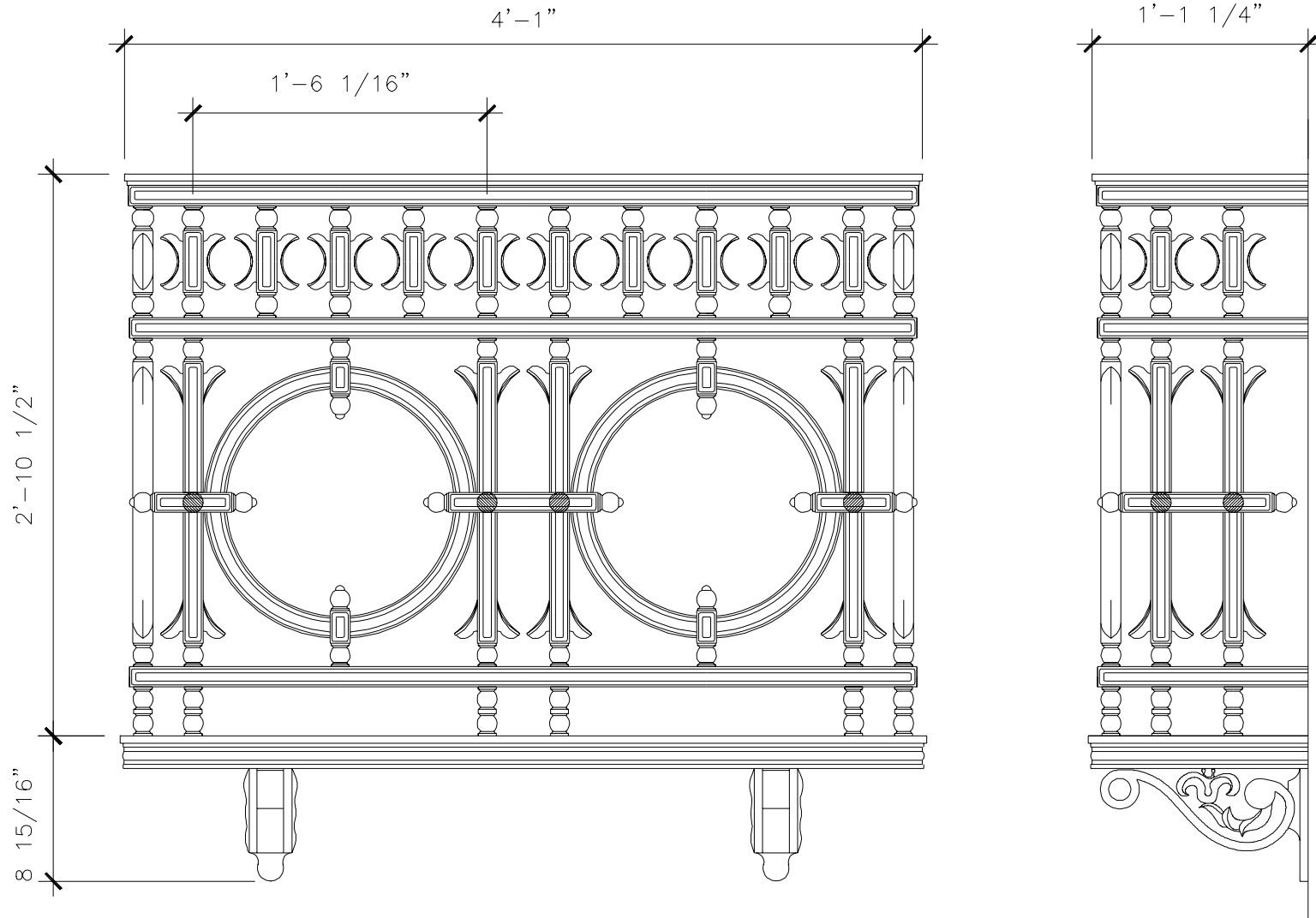

RECOMMENDED MATERIALS

ALUMINUM
BRONZE

FINISHES

PAINTED, ANTIQUED
PATINA, BRUSHED, HAND RUBBED



RAILING

RL002

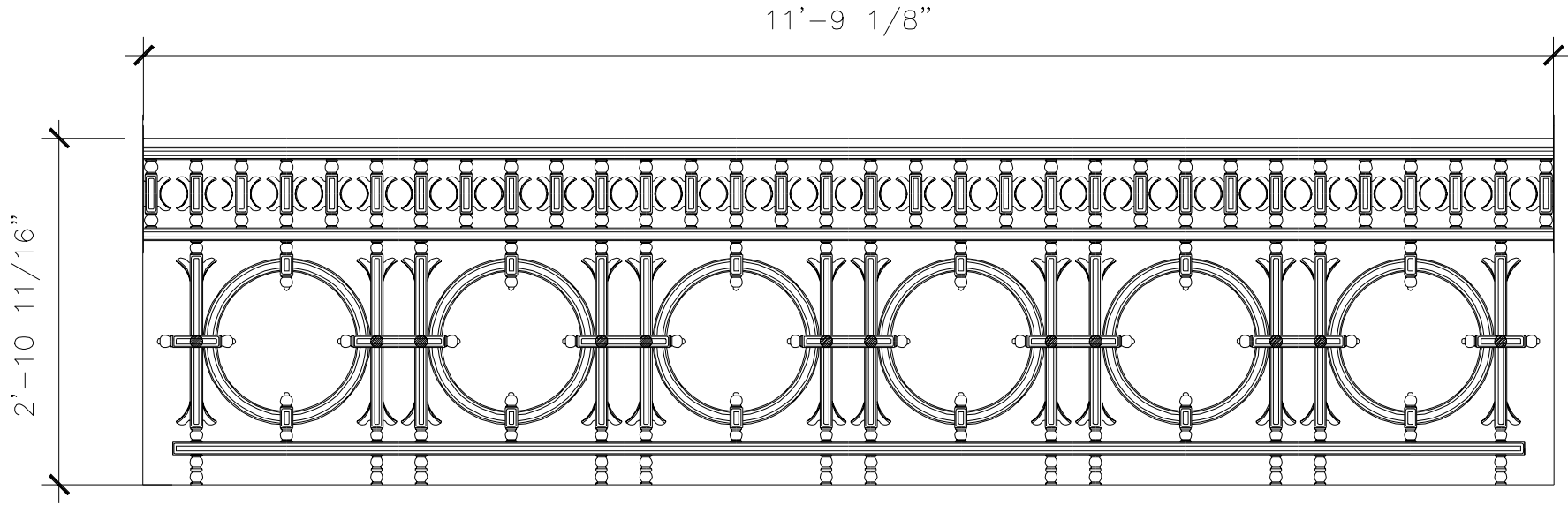

RECOMMENDED MATERIALS

IRON
ALUMINUM
BRONZE

FINISHES

PAINTED
PAINTED, ANTIQUED
PATINA, BRUSHED, HAND RUBBED

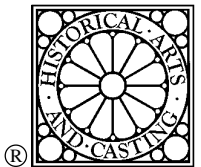

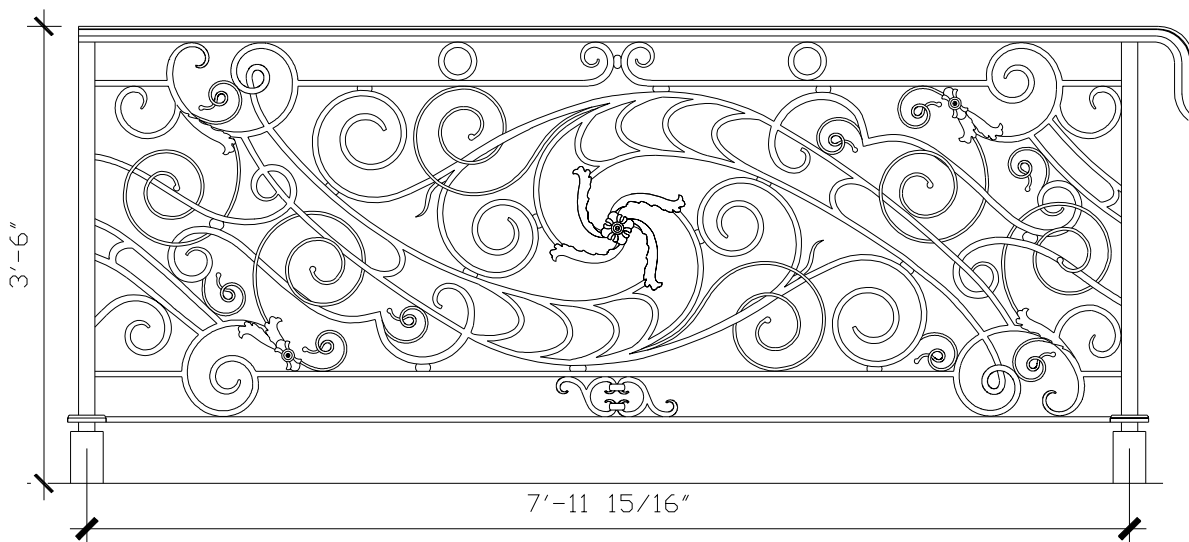
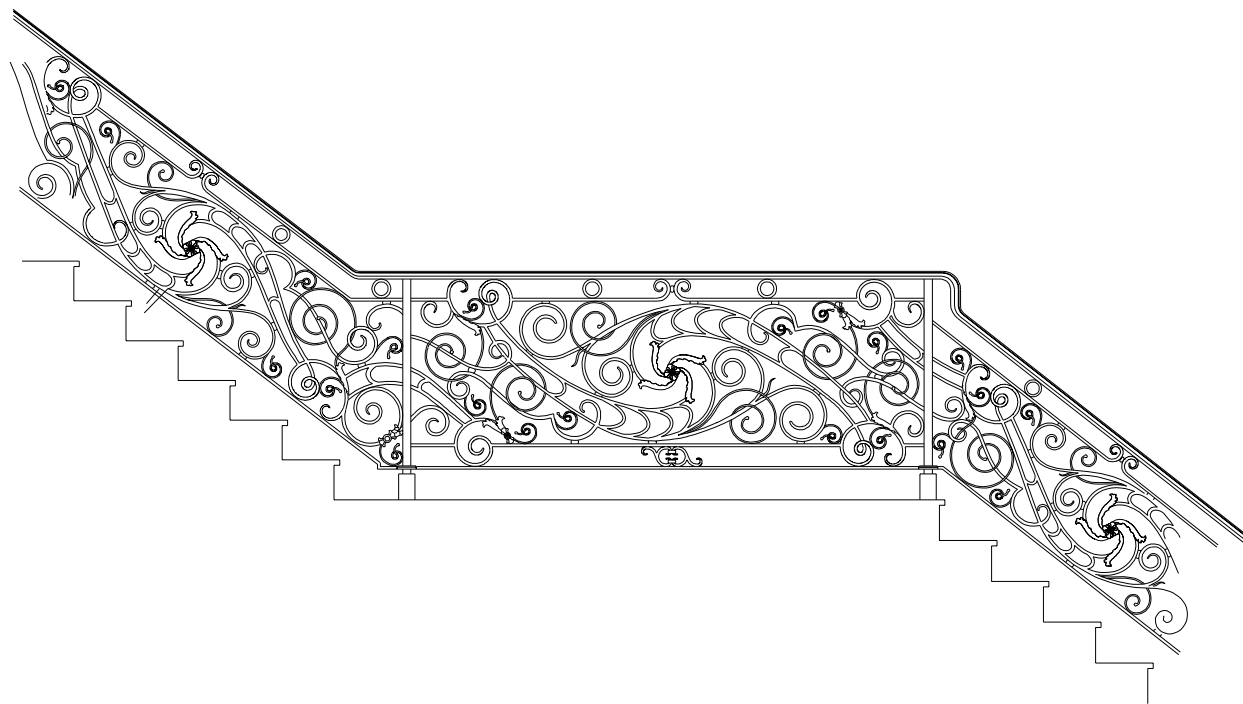

RECOMMENDED MATERIALS

ALUMINUM
BRONZE

FINISHES

PAINTED, ANTIQUED
PATINA, BRUSHED, HAND RUBBED



RAILING

RL004

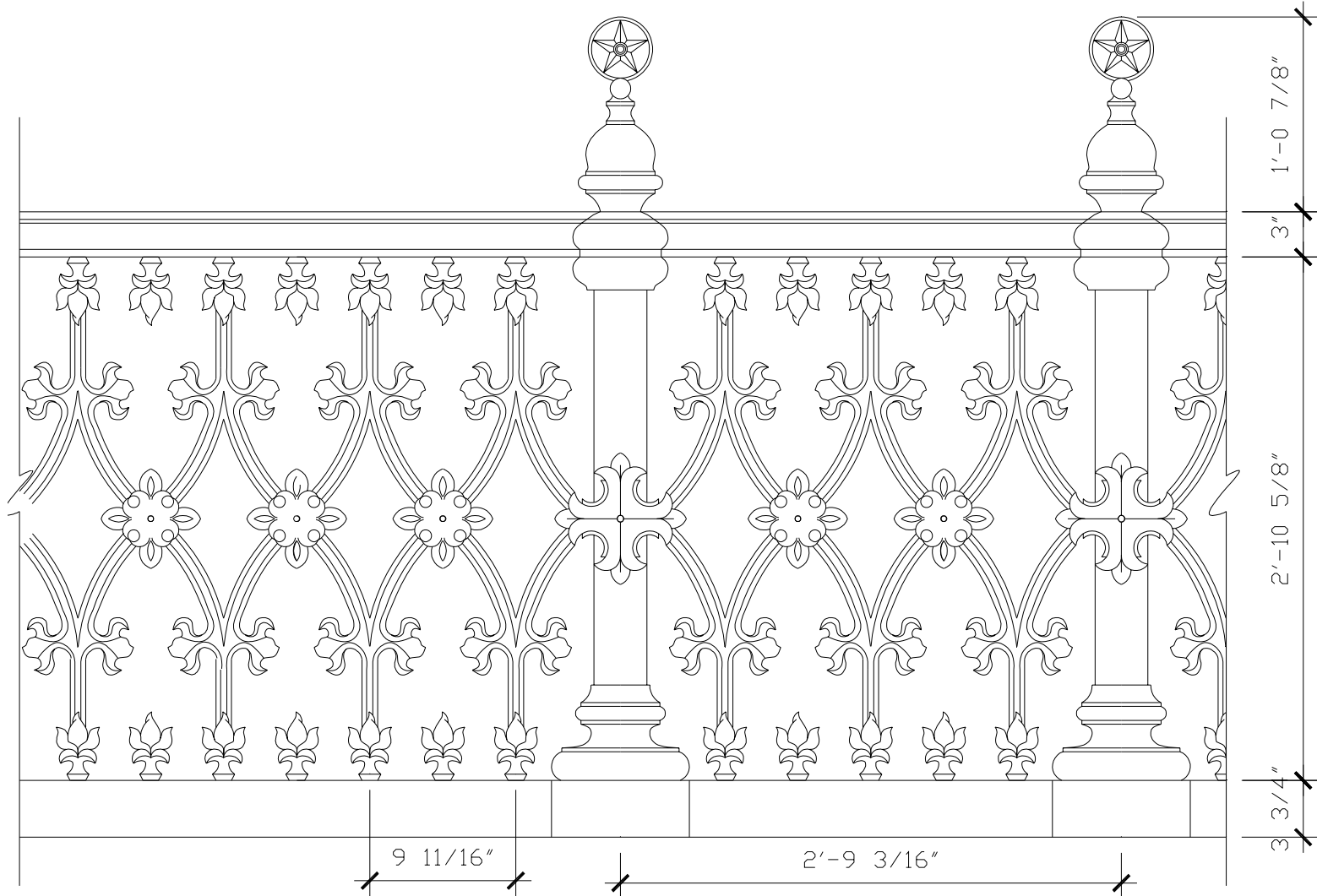

RECOMMENDED MATERIALS

ALUMINUM
BRONZE

FINISHES

PAINTED, ANTIQUED
PATINA, BRUSHED, HAND RUBBED



RAILING

RL006

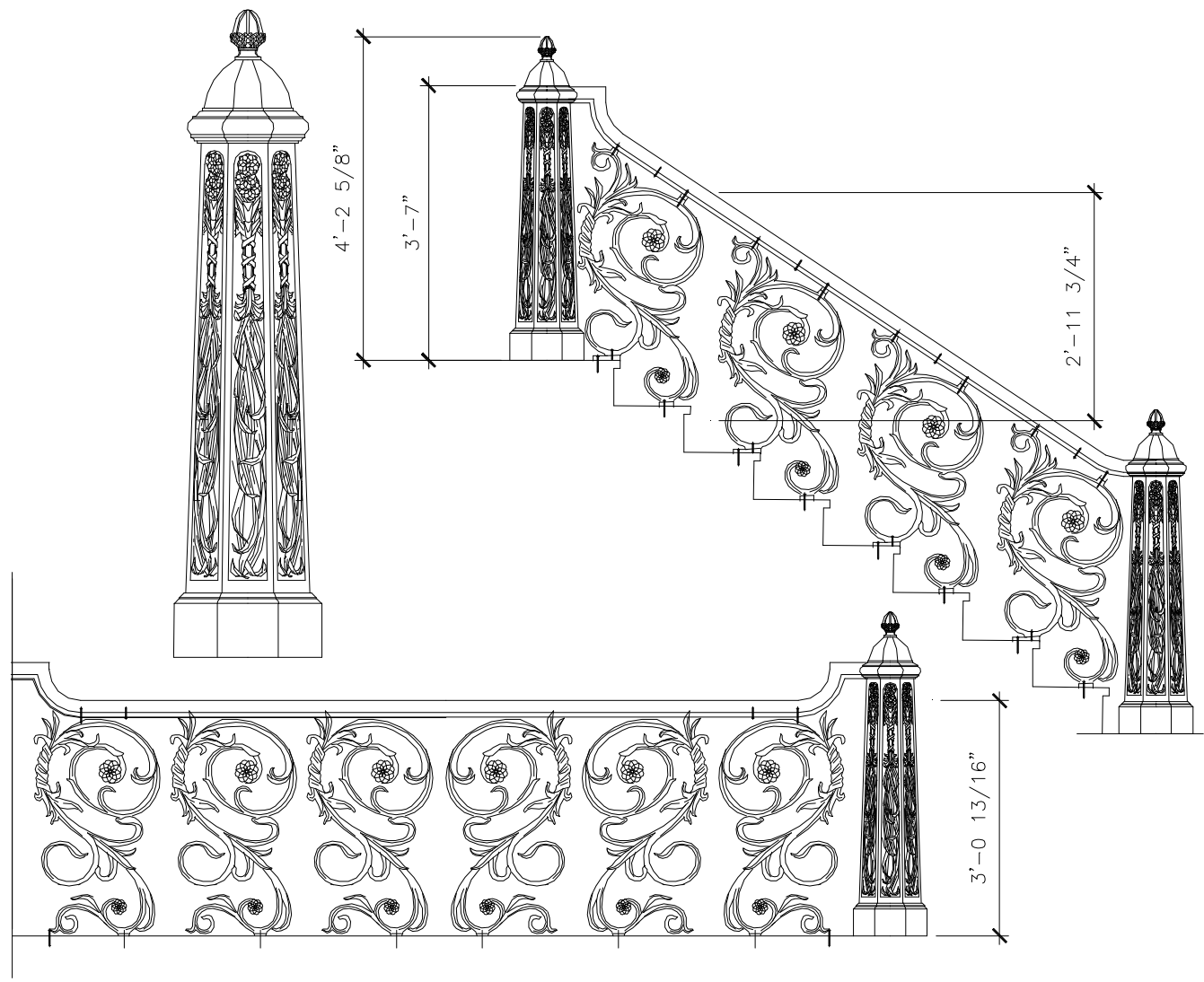

RECOMMENDED MATERIALS

- IRON
- ALUMINUM
- BRONZE

FINISHES

- PAINTED
- PAINTED, ANTIQUED
- PATINA, BRUSHED, HAND RUBBED

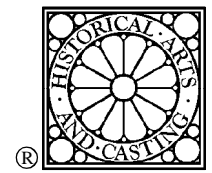

RAILING

RL007

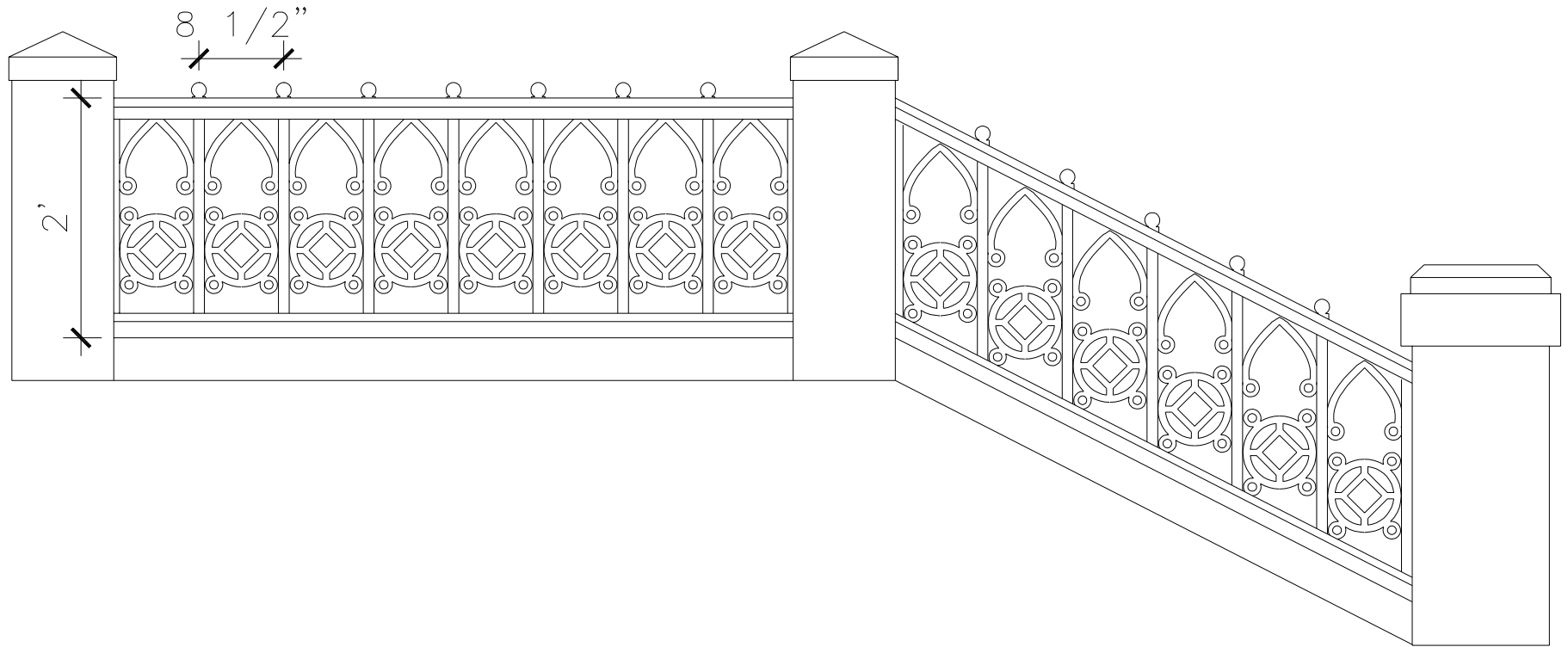

RECOMMENDED MATERIALS

ALUMINUM
BRONZE

FINISHES

PAINTED, ANTIQUED
PATINA, BRUSHED, HAND RUBBED

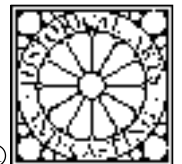

®

RAILING

RL008

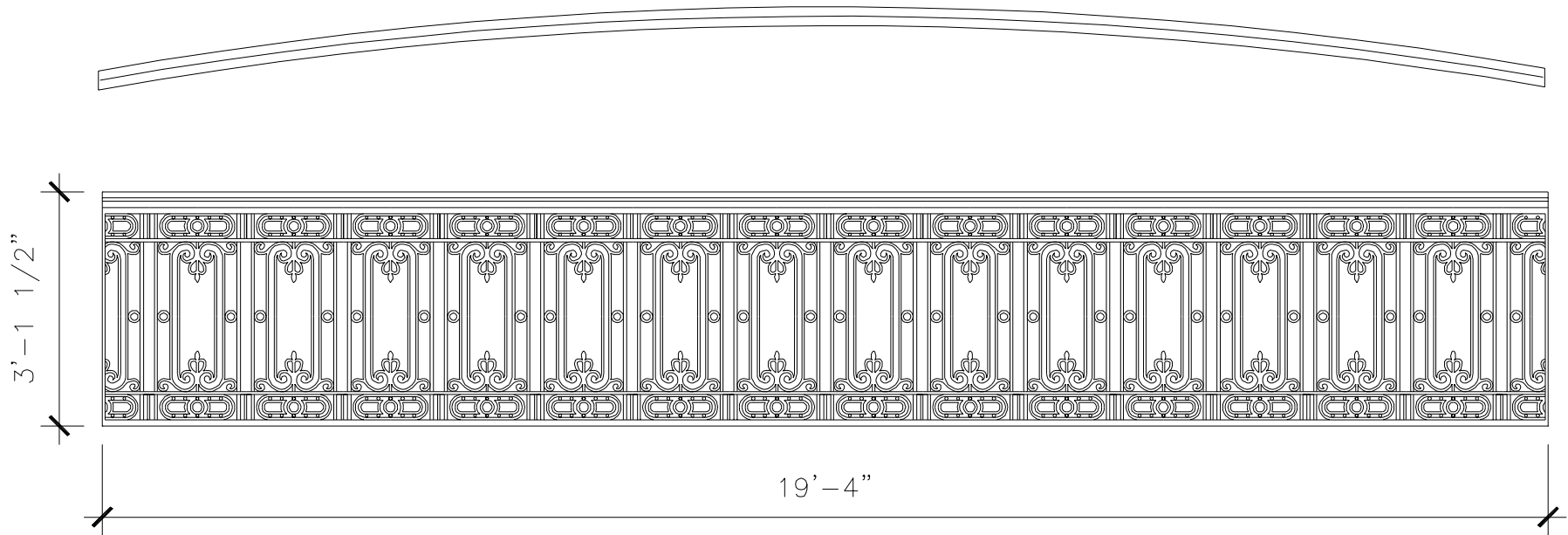

RECOMMENDED MATERIALS

IRON
ALUMINUM
BRONZE

FINISHES

PAINTED
PAINTED, ANTIQUED
PATINA, BRUSHED, HAND RUBBED

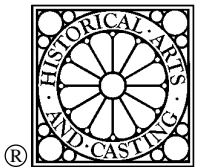

EAGLE RAILING

RL009

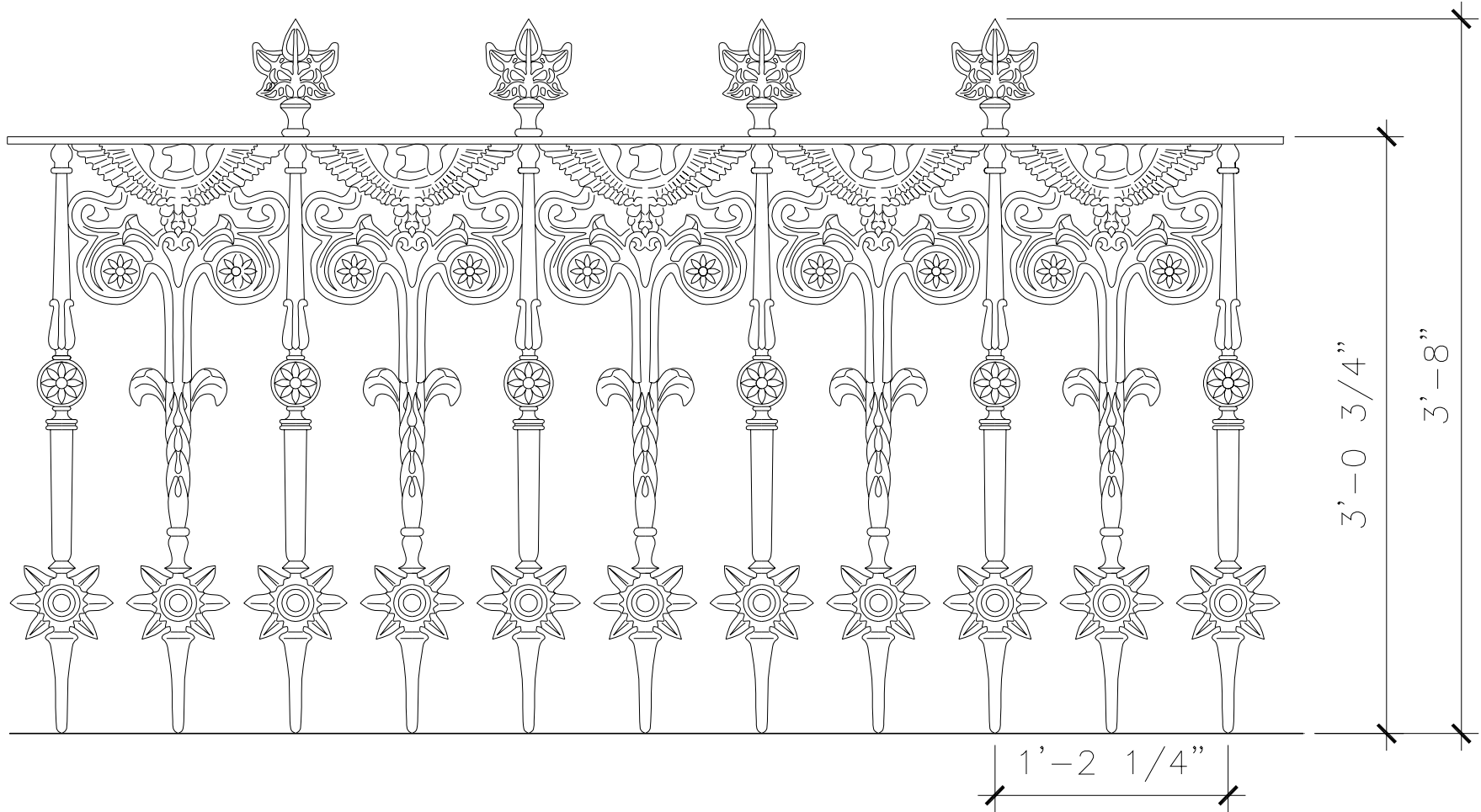

RECOMMENDED MATERIALS

IRON
ALUMINUM
BRONZE

FINISHES

PAINTED
PAINTED, ANTIQUED
PATINA, BRUSHED, HAND RUBBED

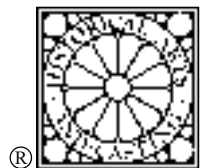

RAILING

RL010

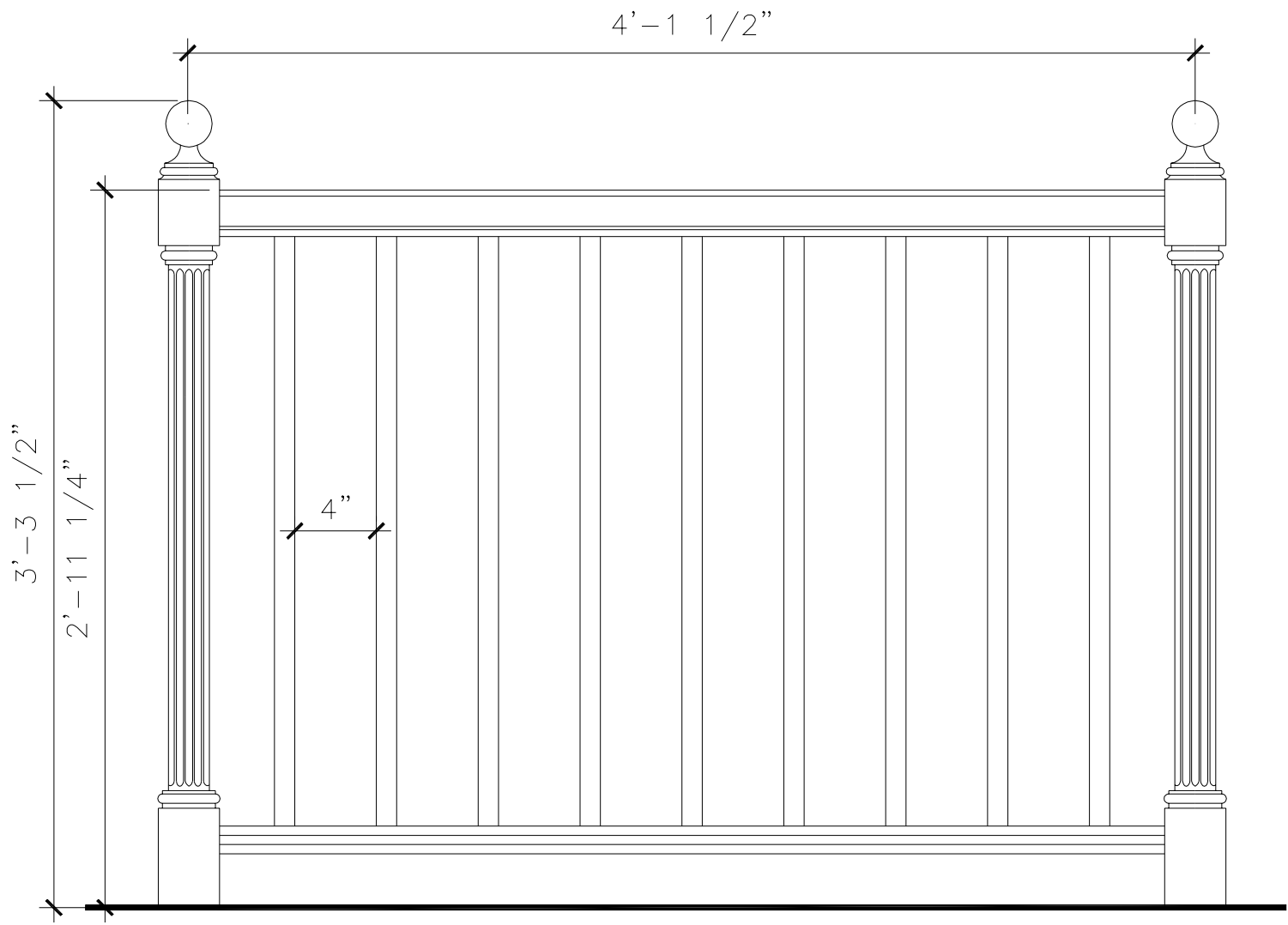

RECOMMENDED MATERIALS

IRON
ALUMINUM
BRONZE

FINISHES

PAINTED
PAINTED, ANTIQUED
PATINA, BRUSHED, HAND RUBBED

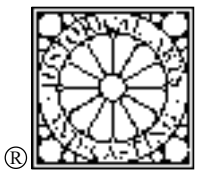

RAILING

RL011

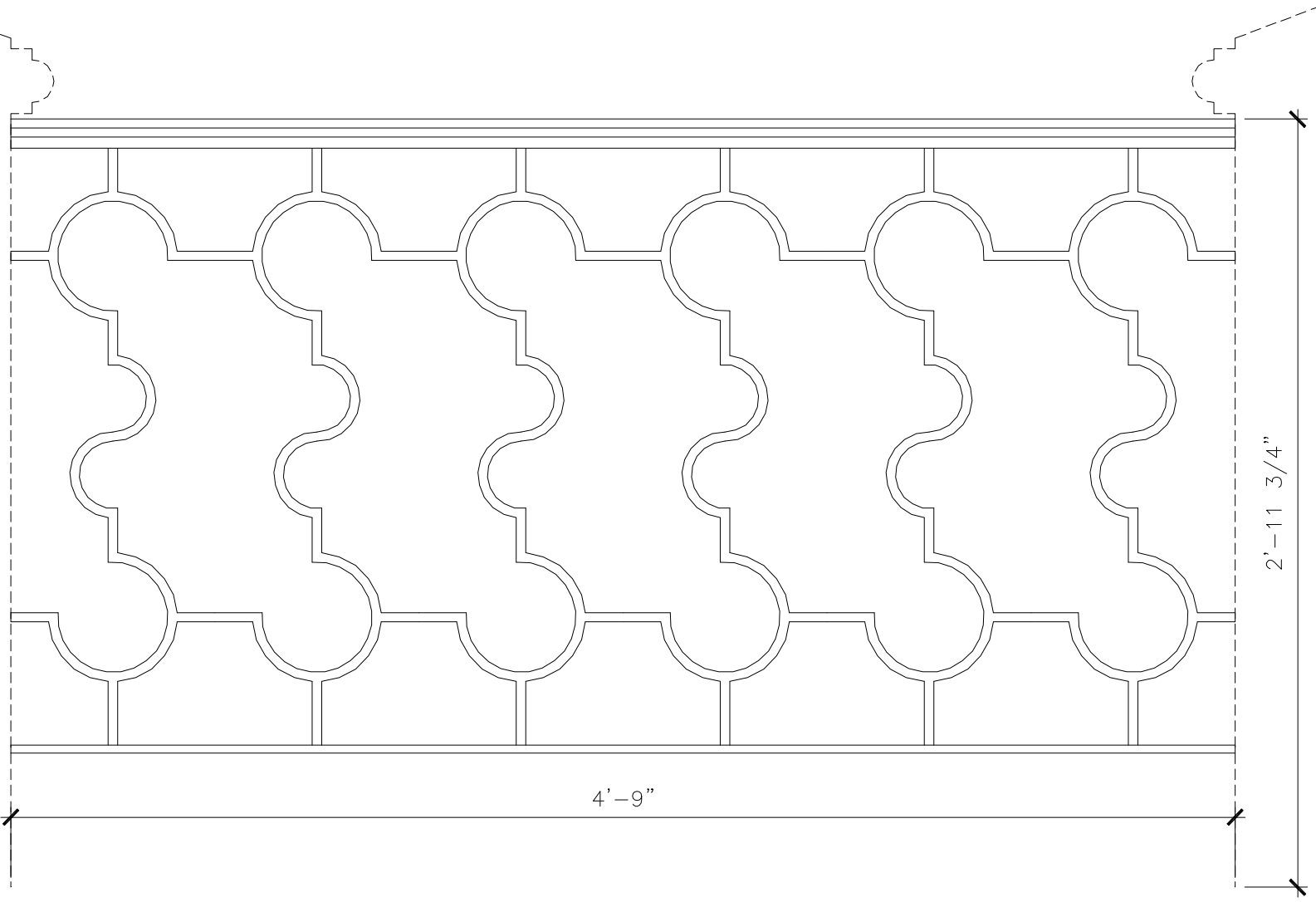

RECOMMENDED MATERIALS

ALUMINUM
BRONZE

FINISHES

PAINTED, ANTIQUED
PATINA, BRUSHED, HAND RUBBED

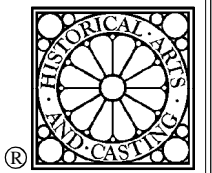

RAILING

RL013

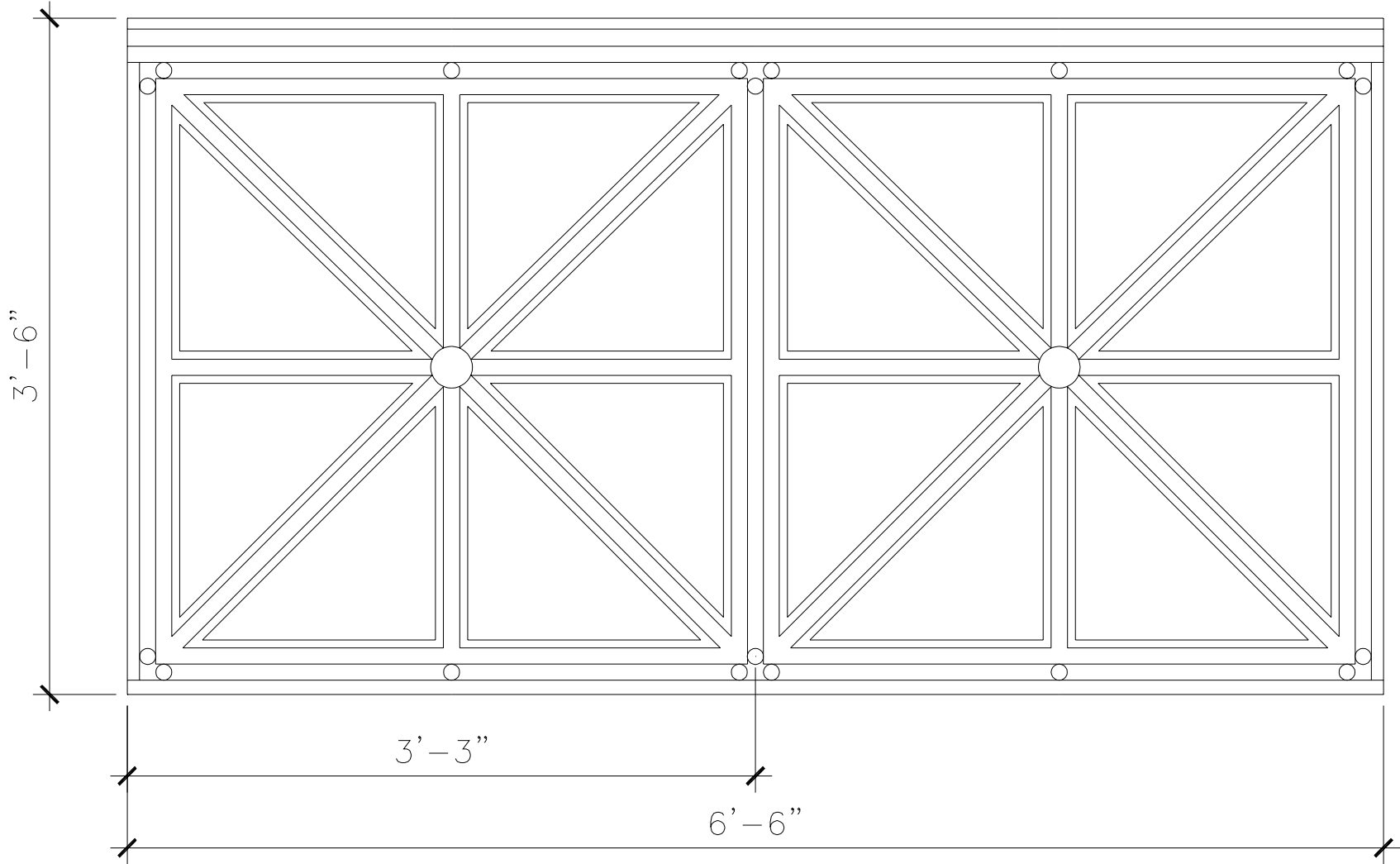

RECOMMENDED MATERIALS

ALUMINUM
BRONZE

FINISHES

PAINTED, ANTIQUED
PATINA, BRUSHED, HAND RUBBED

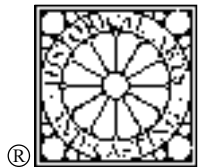

RAILING

RL014

16'-7 1/16"

4'-2 3/4"

3'-9 15/16"

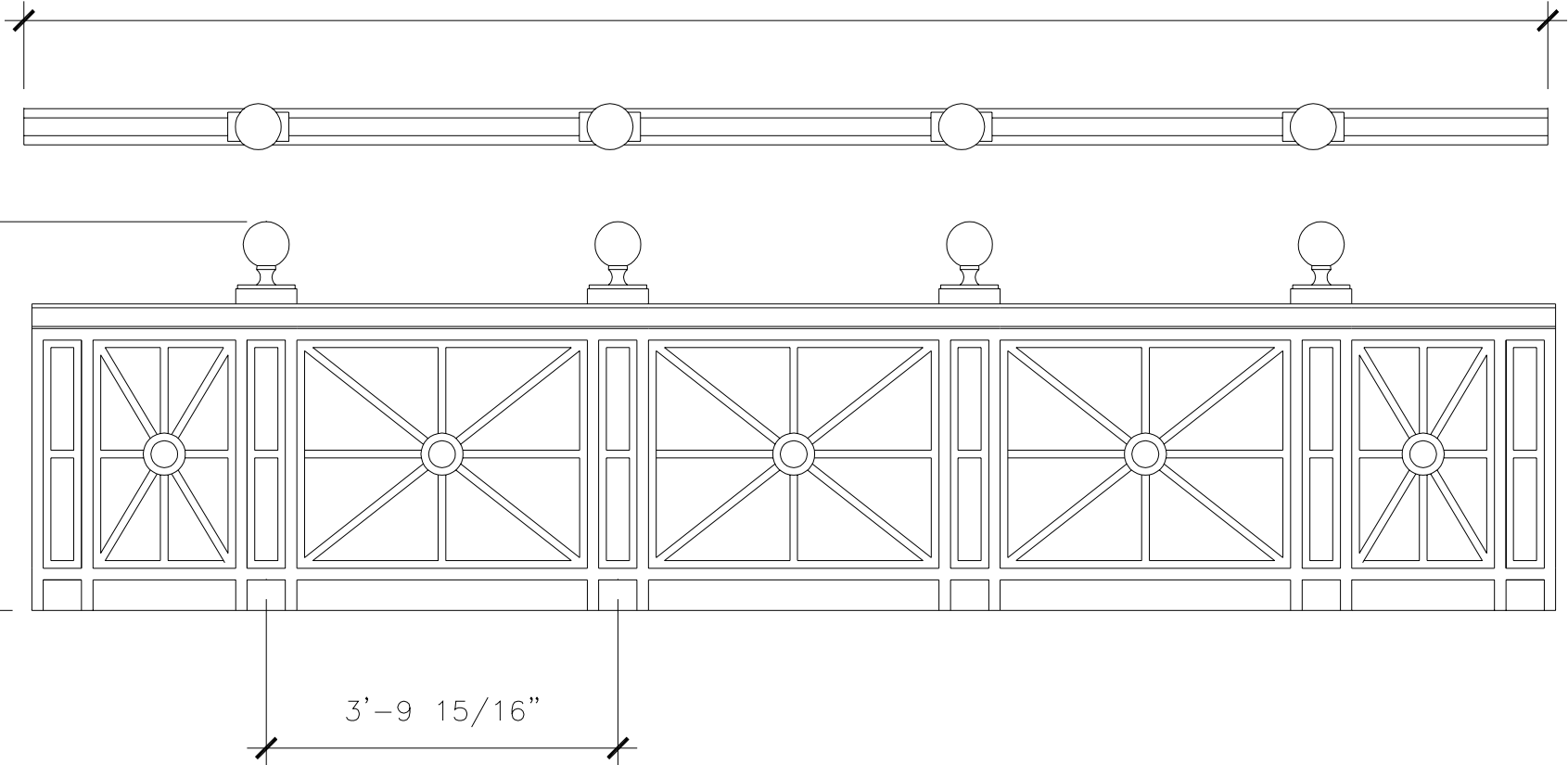

RECOMMENDED MATERIALS

ALUMINUM
BRONZE

FINISHES

PAINTED, ANTIQUED
PATINA, BRUSHED, HAND RUBBED

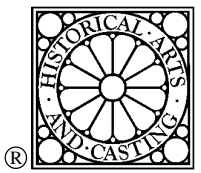

RAILING

RL026

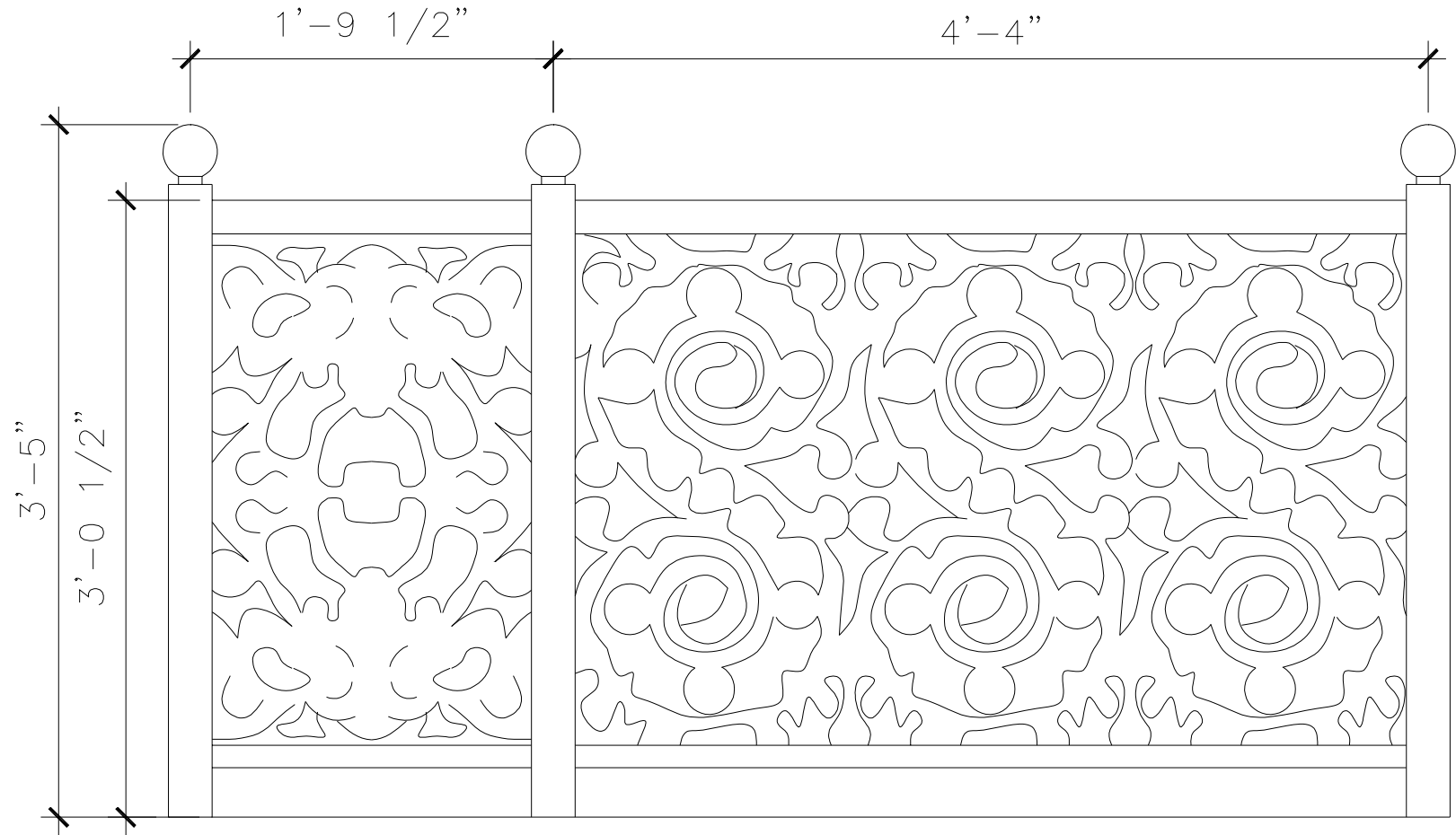

RECOMMENDED MATERIALS

ALUMINUM
BRONZE

FINISHES

PAINTED, ANTIQUED
PATINA, BRUSHED, HAND RUBBED

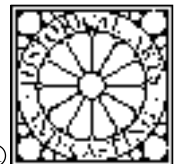

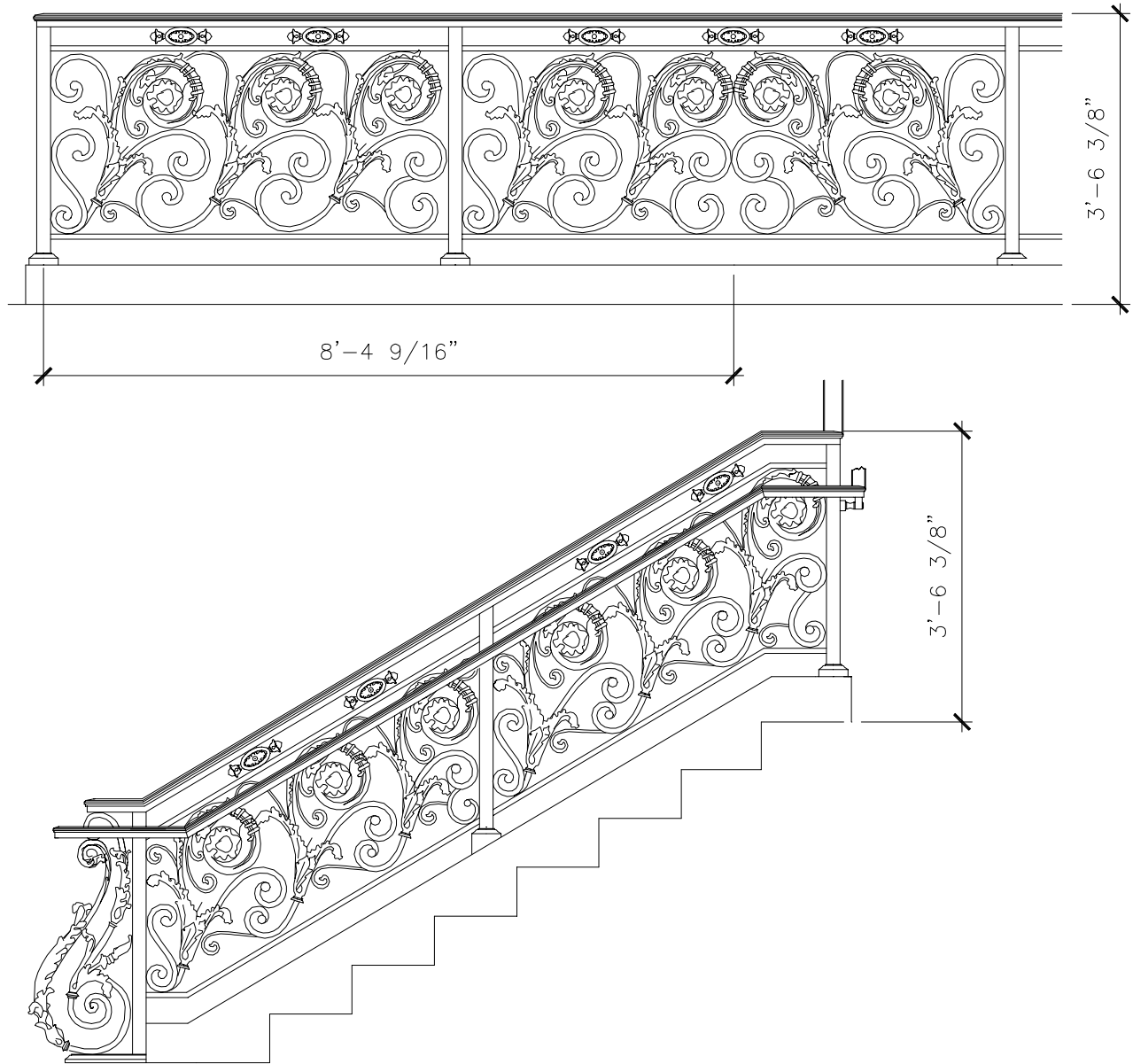

RECOMMENDED MATERIALS

ALUMINUM
BRONZE

FINISHES

PAINTED, ANTIQUED
PATINA, BRUSHED, HAND RUBBED

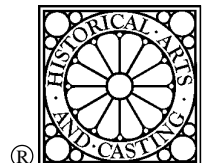

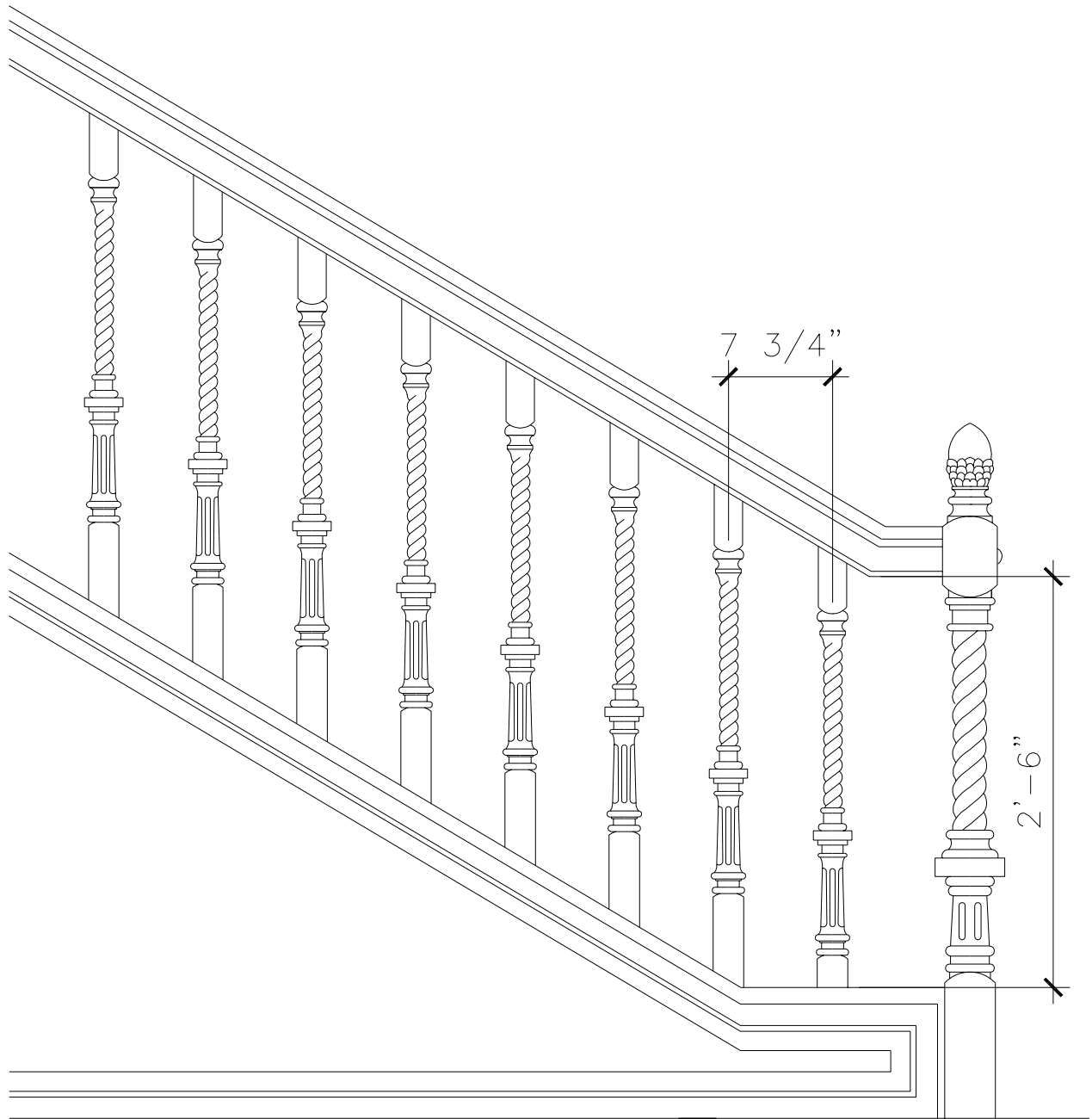

RECOMMENDED MATERIALS

IRON
ALUMINUM

FINISHES

PAINTED
PAINTED, ANTIQUED

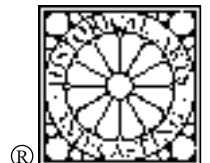

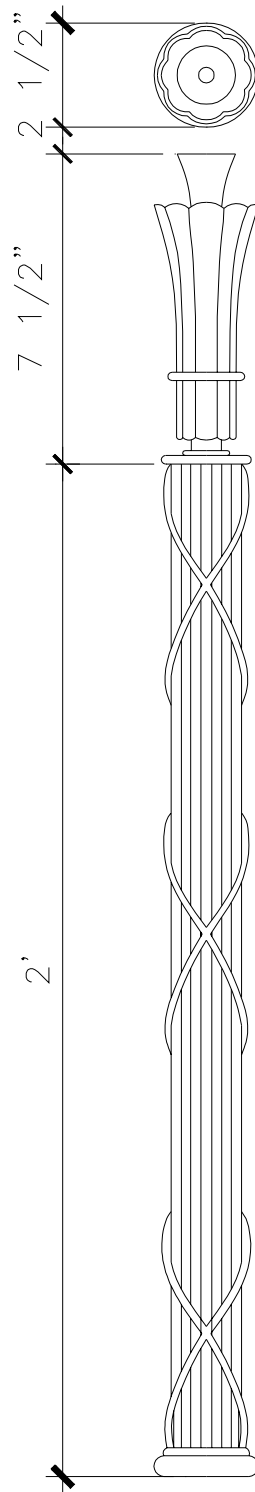

RECOMMENDED MATERIALS

IRON
ALUMINUM

FINISHES

PAINTED
PAINTED, ANTIQUED

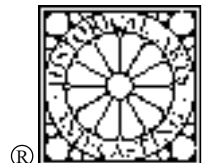

BALCONY

RL030

6'-5 3/4"

2'-11 1/4"

1'-10"

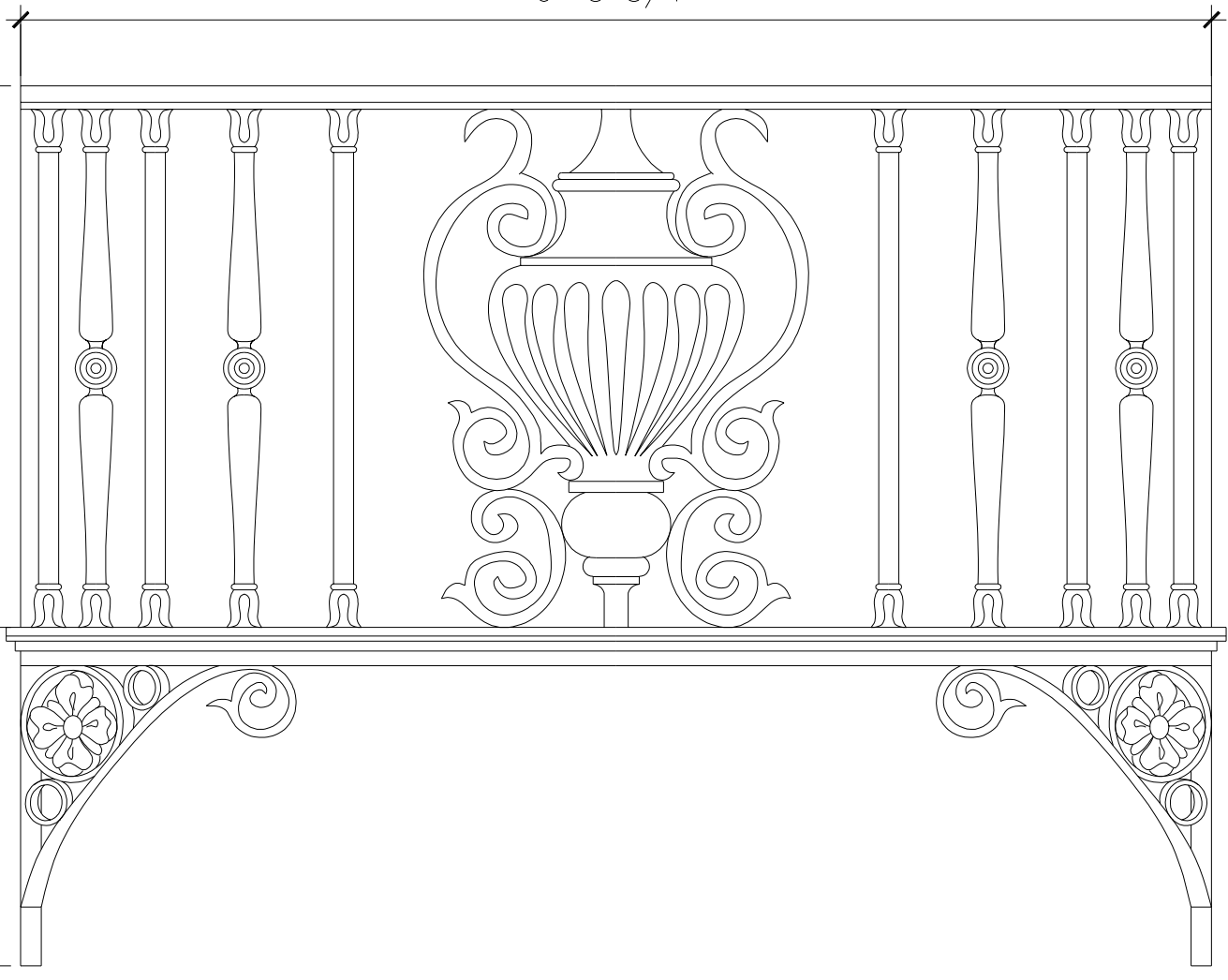

RECOMMENDED MATERIALS

ALUMINUM
BRONZE

FINISHES

PAINTED, ANTIQUED
PATINA, BRUSHED, HAND RUBBED

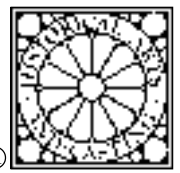

®

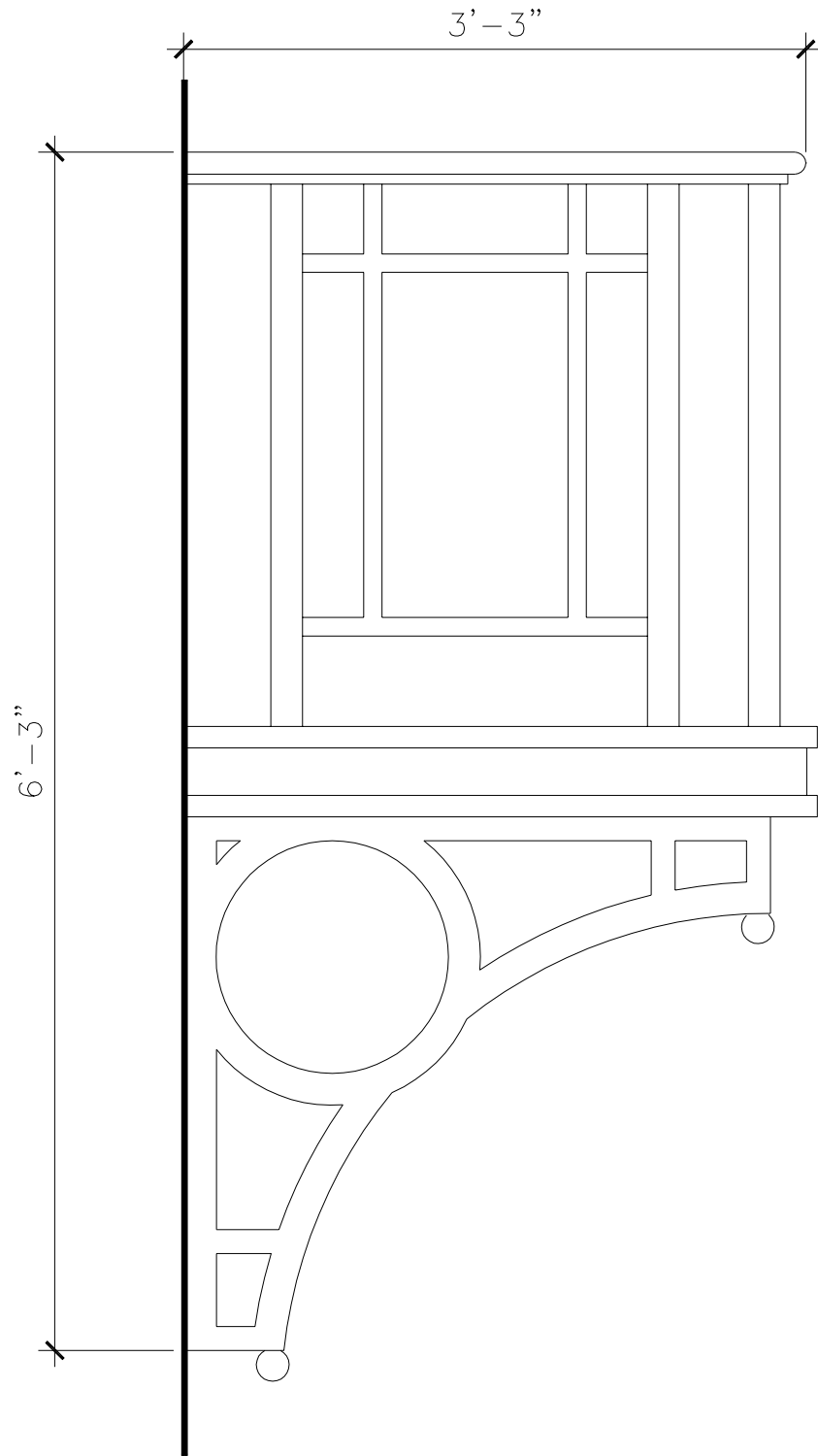

RECOMMENDED MATERIALS

IRON
ALUMINUM

FINISHES

PAINTED
PAINTED, ANTIQUED

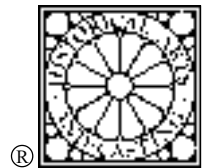

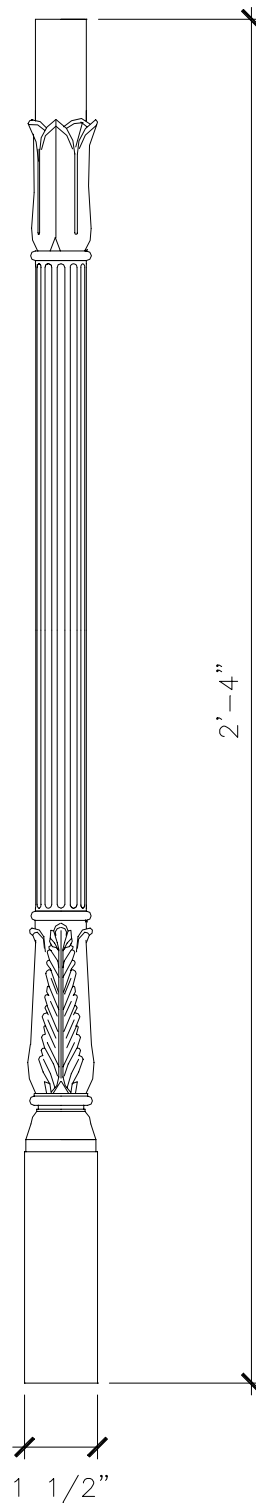

RECOMMENDED MATERIALS

ALUMINUM
BRONZE

FINISHES

PAINTED, ANTIQUED
PATINA, BRUSHED, HAND RUBBED



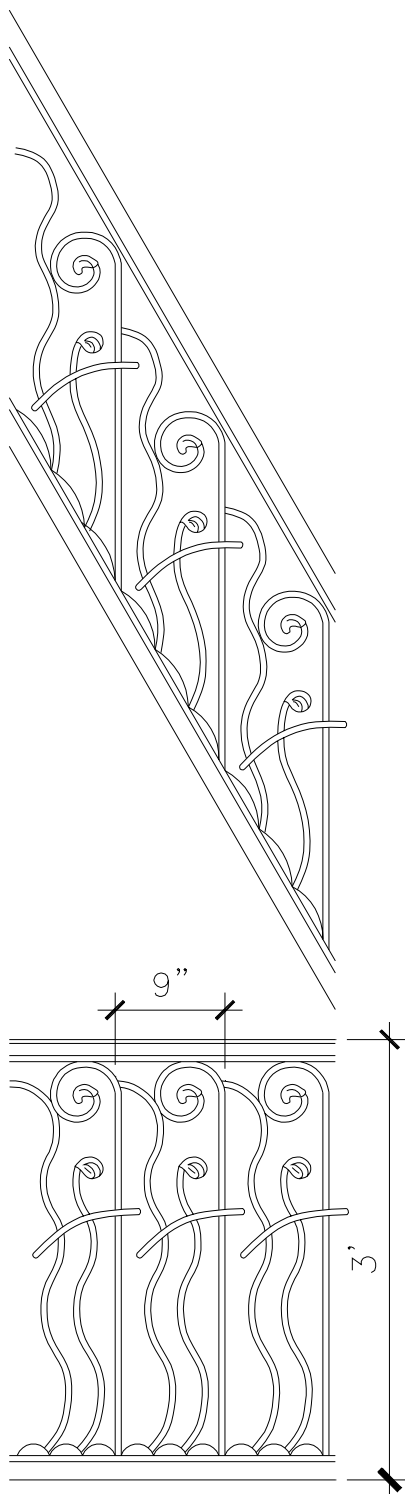

RECOMMENDED MATERIALS

IRON
ALUMINUM

FINISHES

PAINTED
PAINTED, ANTIQUED

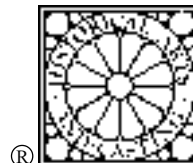

RAILING

RL034

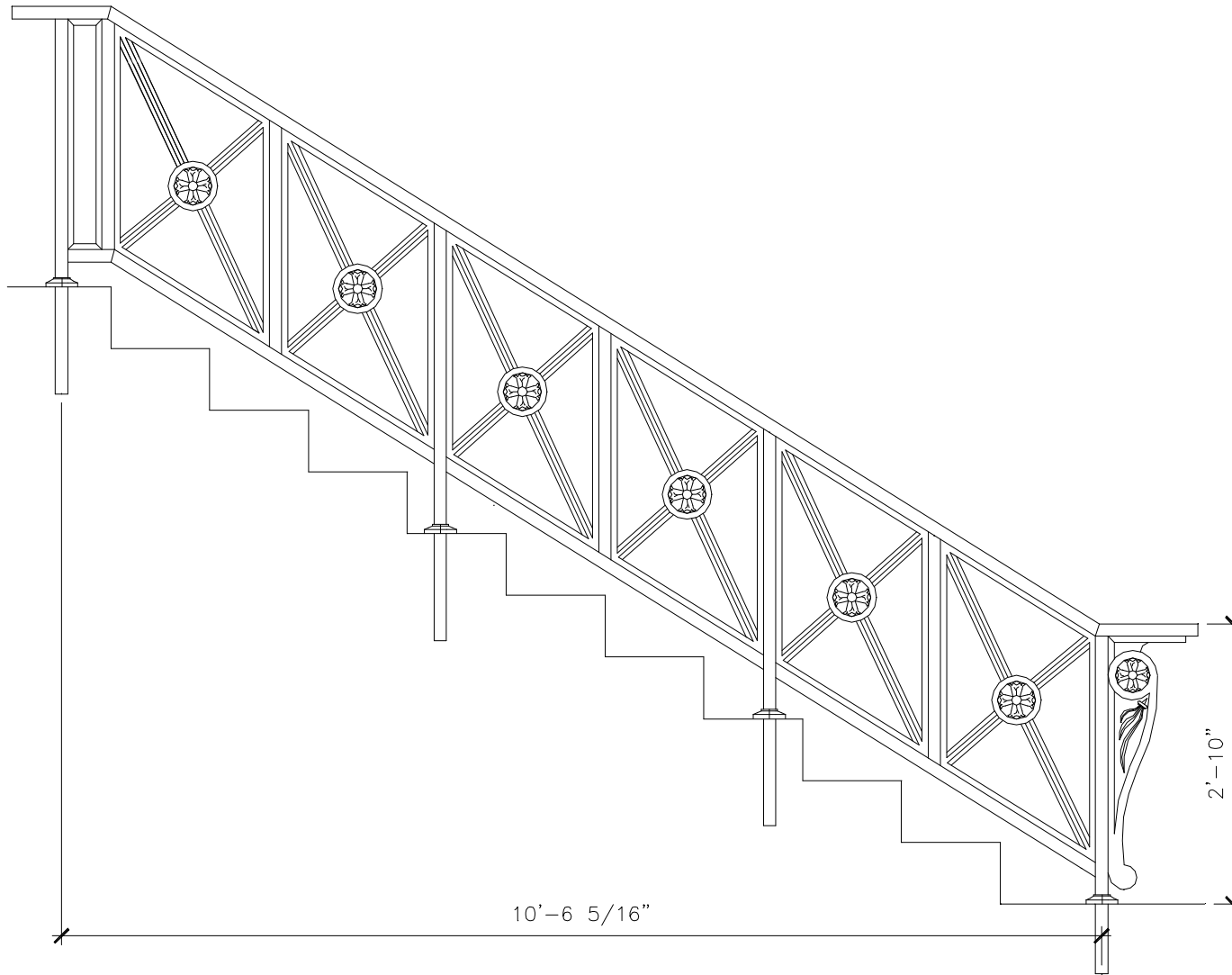

RECOMMENDED MATERIALS

IRON
ALUMINUM
BRONZE

FINISHES

PAINTED
PAINTED, ANTIQUED
PATINA, BRUSHED, HAND RUBBED

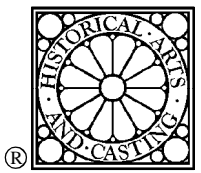

RAILING

RL035

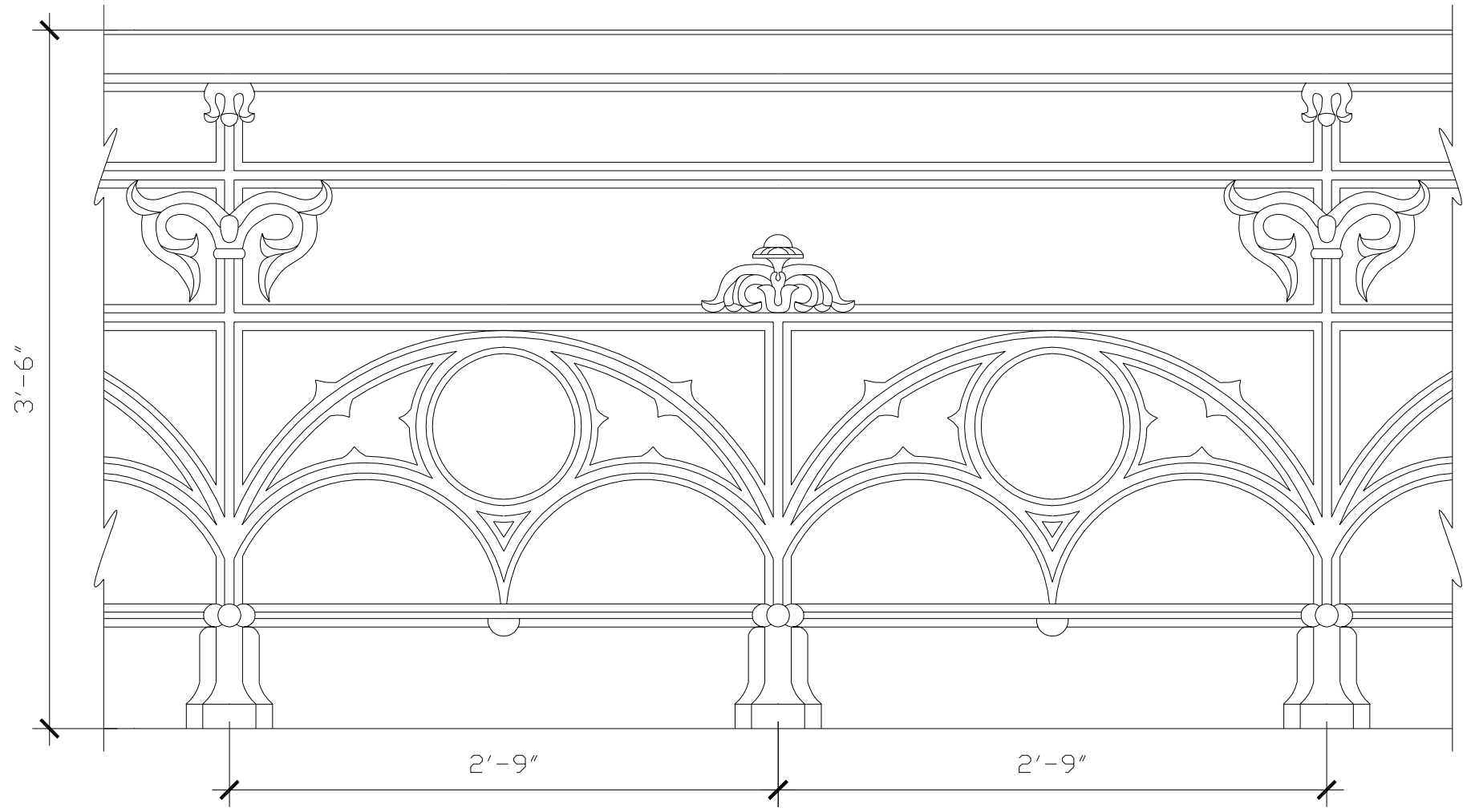

RECOMMENDED MATERIALS

- IRON
- ALUMINUM

FINISHES

- PAINTED
- PAINTED, ANTIQUED

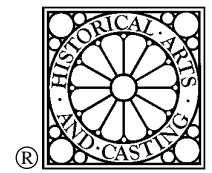

CORNER RAILING

RL035A

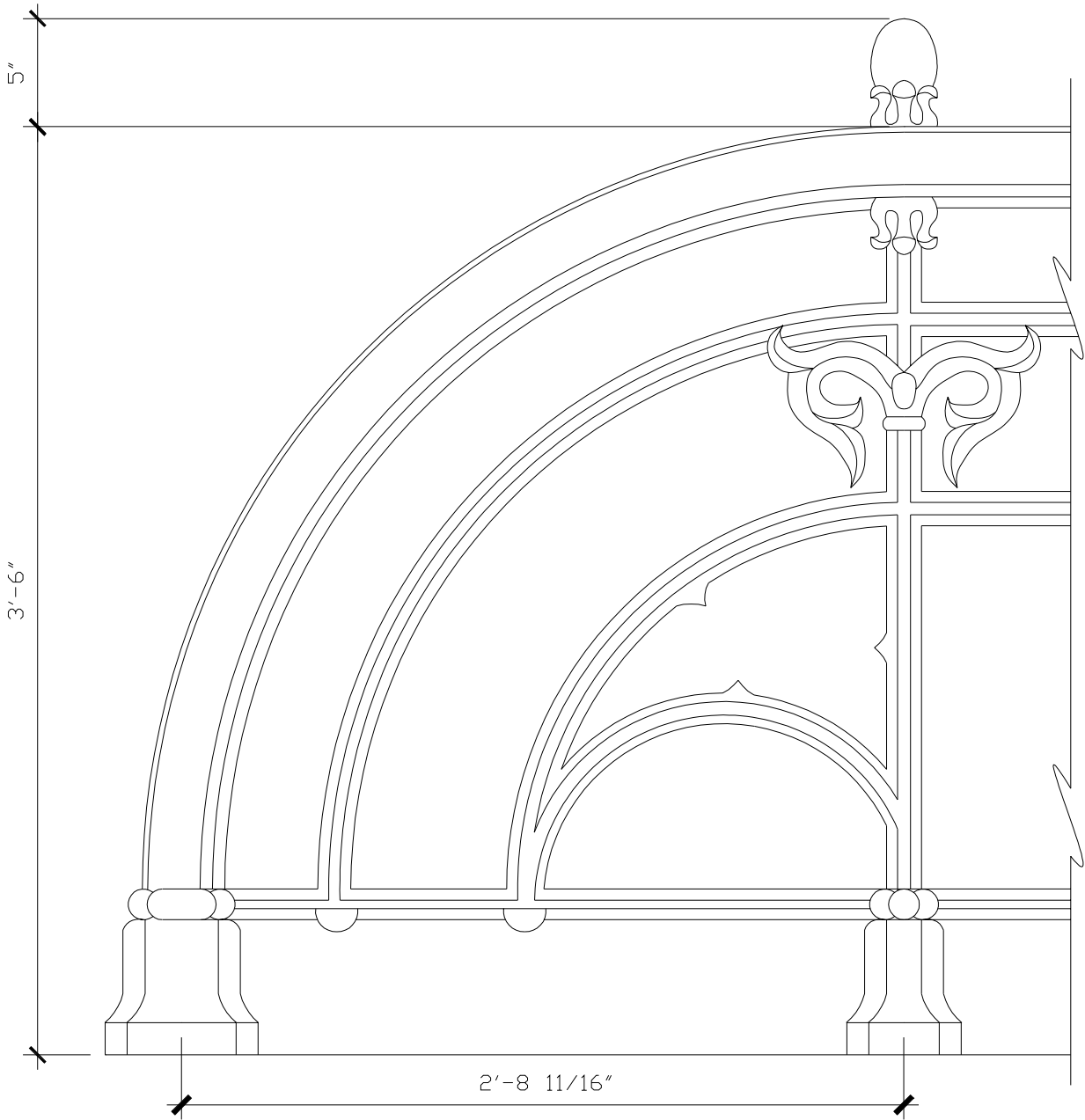

RECOMMENDED MATERIALS

IRON
ALUMINUM

FINISHES

PAINTED
PAINTED, ANTIQUED

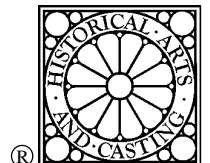

CORNER RAILING

RL035A

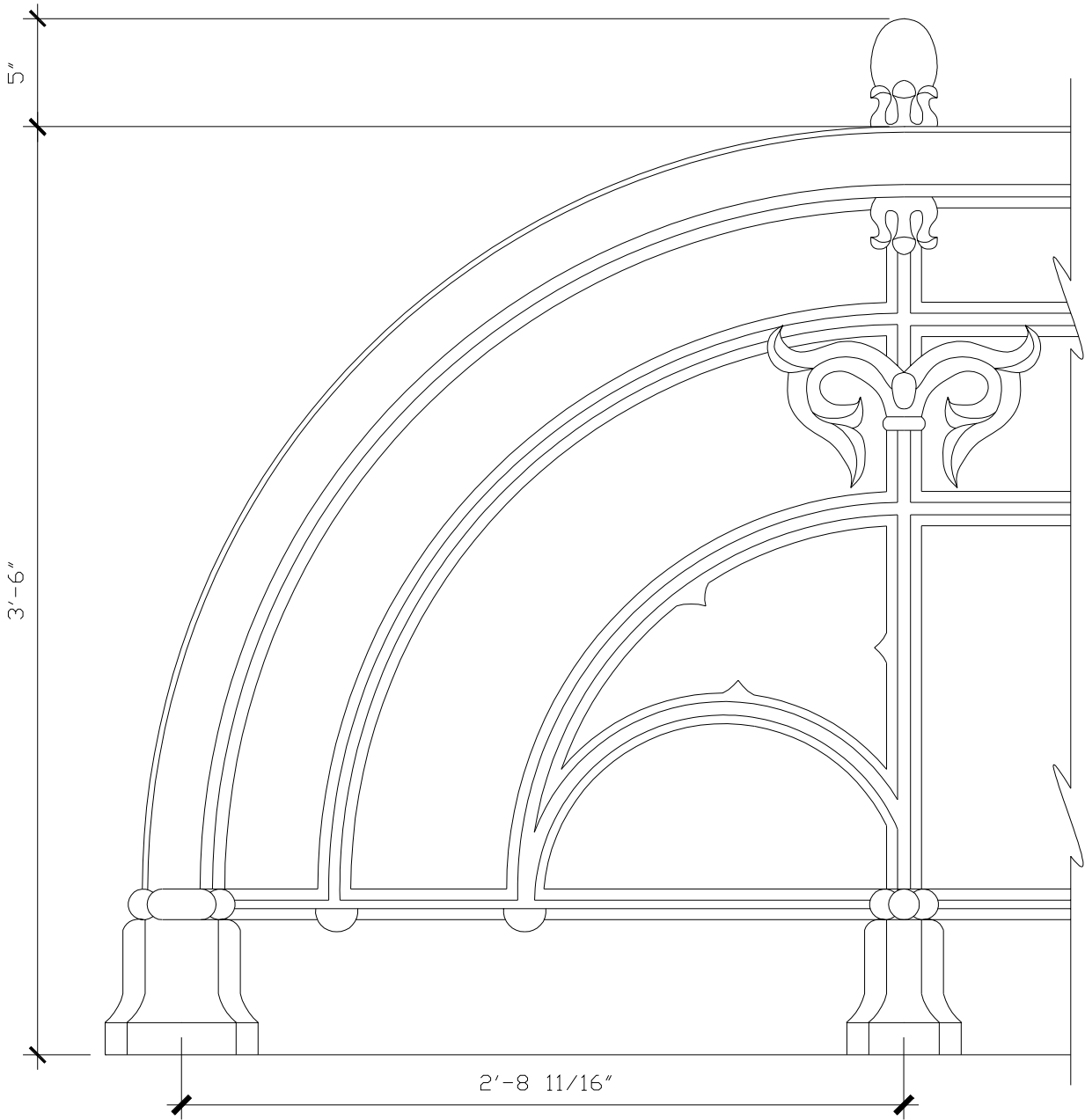

RECOMMENDED MATERIALS

IRON
ALUMINUM

FINISHES

PAINTED
PAINTED, ANTIQUED

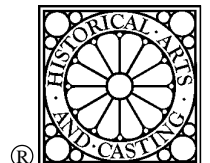

RAILING

RL036

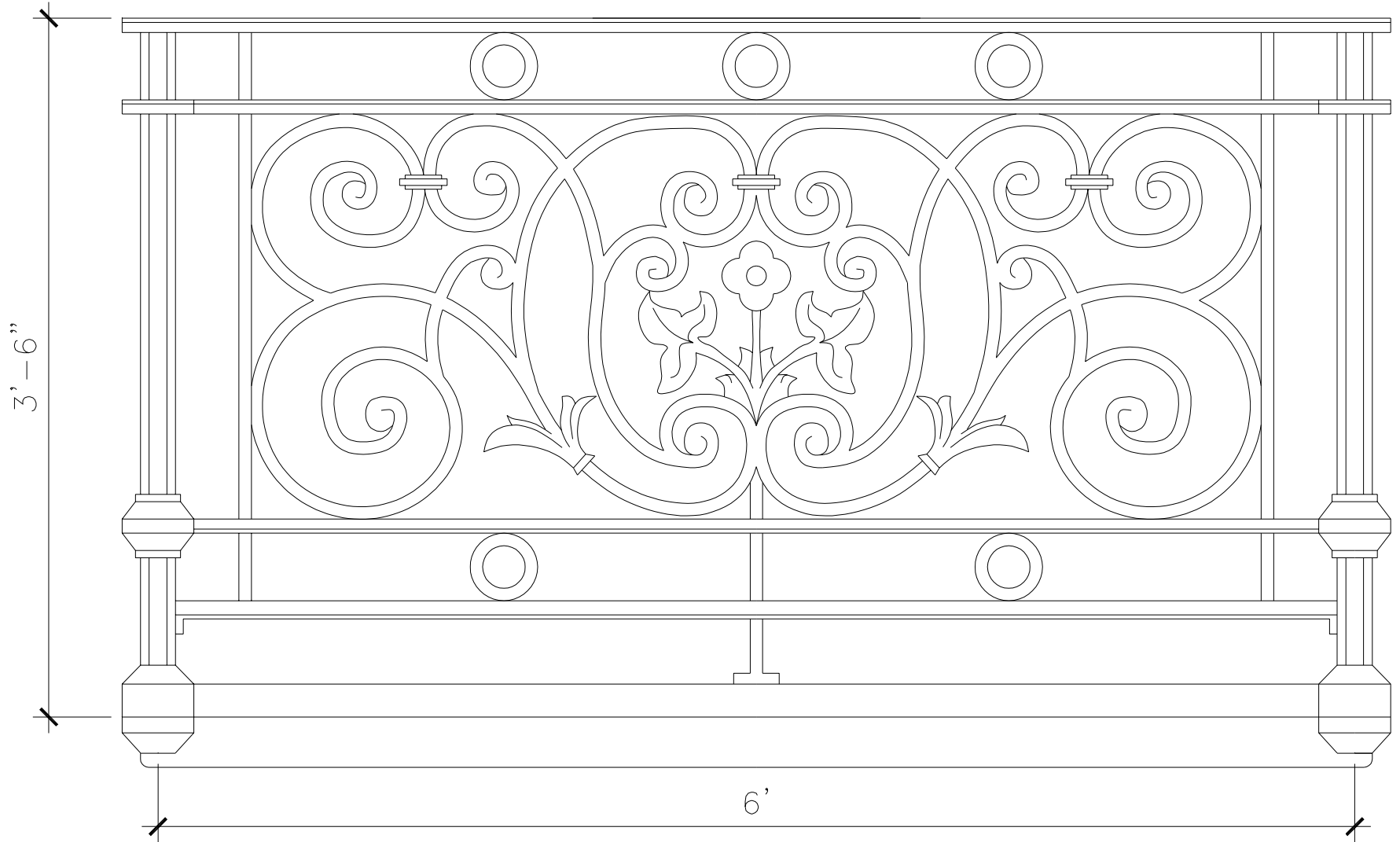

RECOMMENDED MATERIALS

ALUMINUM
BRONZE

FINISHES

PAINTED, ANTIQUED
PATINA, BRUSHED, HAND RUBBED

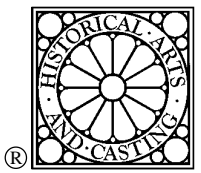

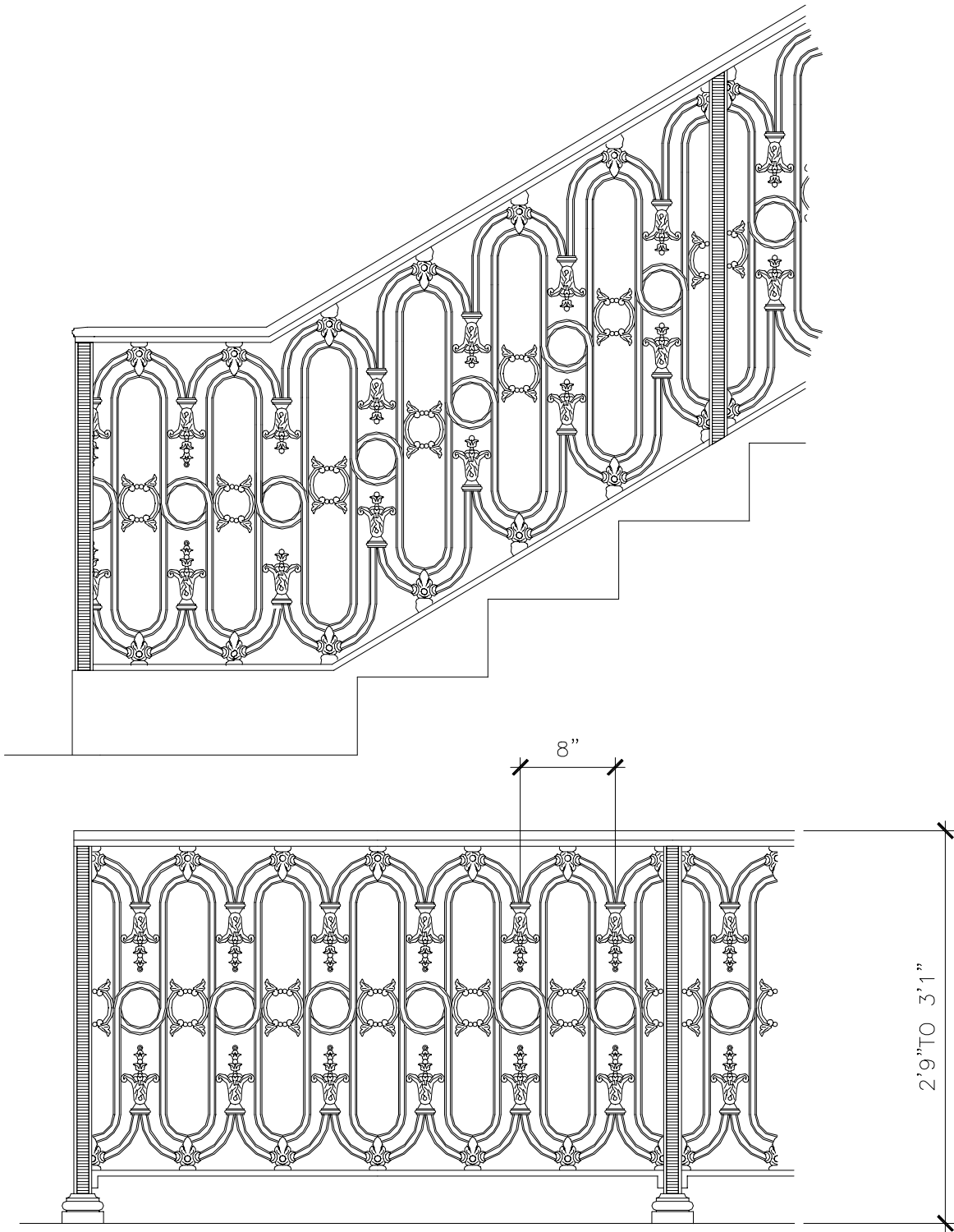

RECOMMENDED MATERIALS

ALUMINUM
BRONZE

FINISHES

PAINTED, ANTIQUED
PATINA, BRUSHED, HAND RUBBED

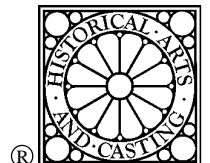

BALUSTER

RL039

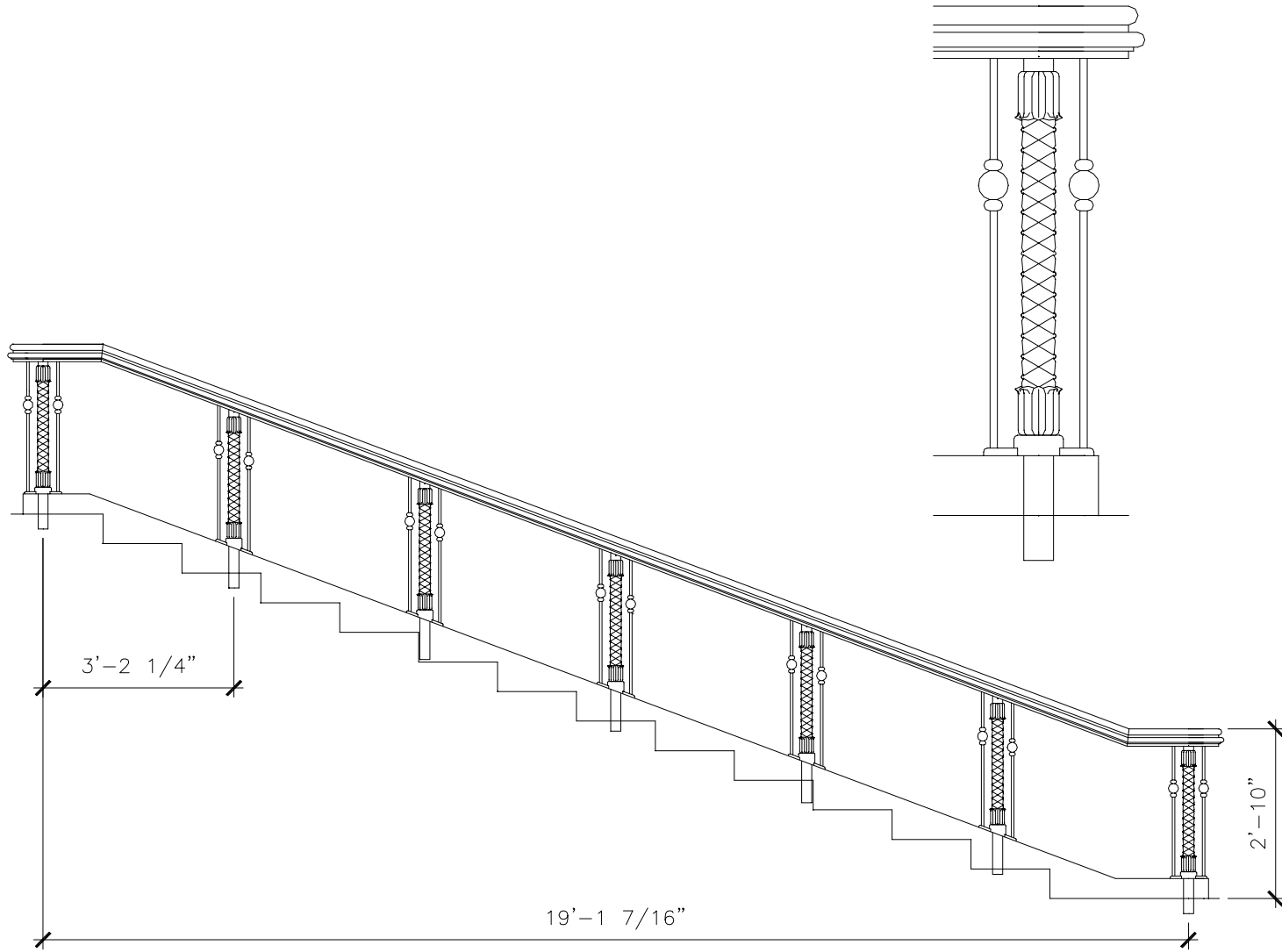

RECOMMENDED MATERIALS

ALUMINUM
BRONZE

FINISHES

PAINTED, ANTIQUED
PATINA, BRUSHED, HAND RUBBED

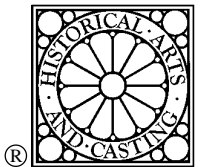

RAIL BRACKETS

RL041

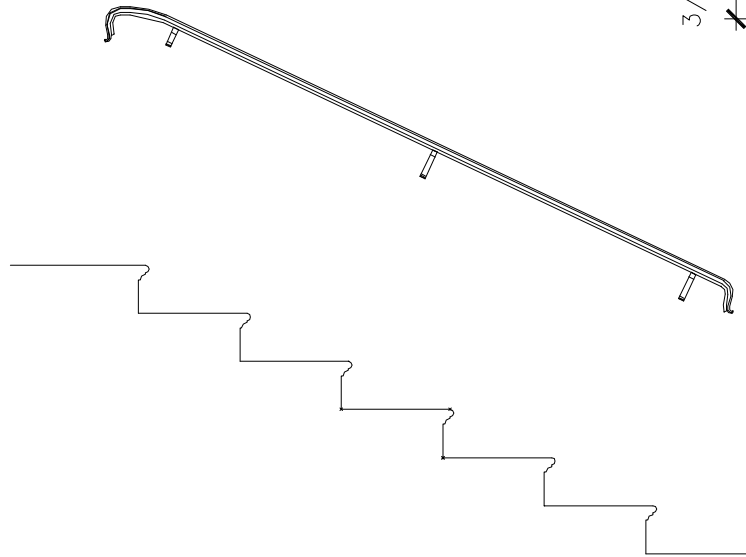
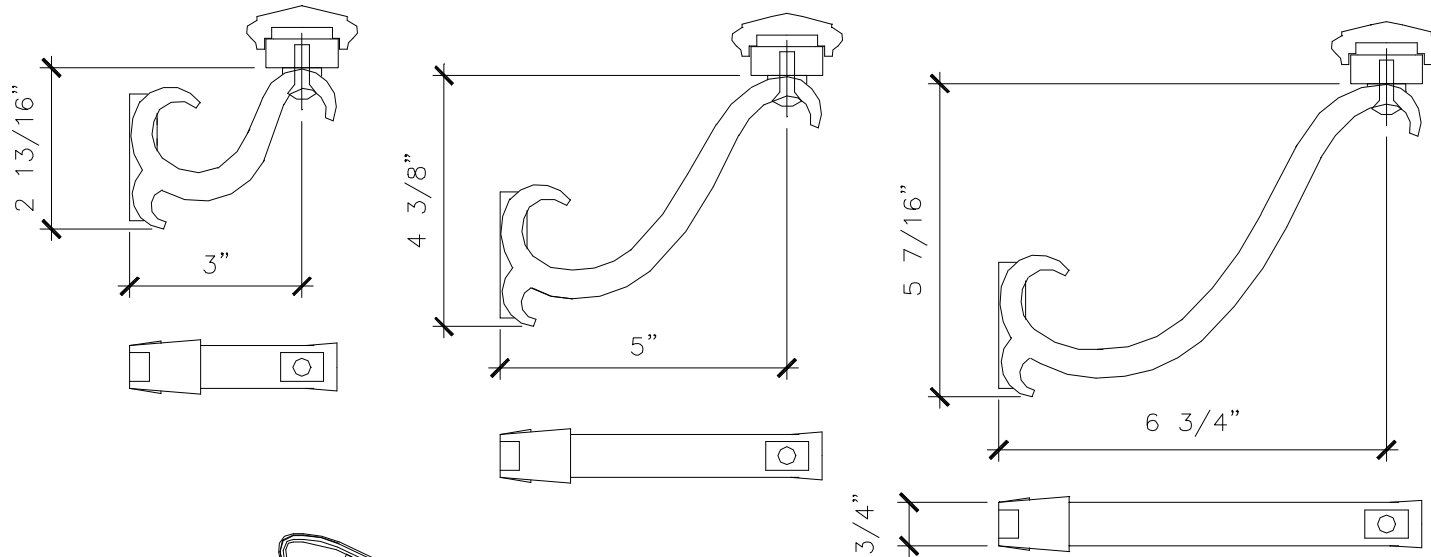

RECOMMENDED MATERIALS

IRON
ALUMINUM
BRONZE

FINISHES

PAINTED
PAINTED, ANTIQUED
PATINA, BRUSHED, HAND RUBBED

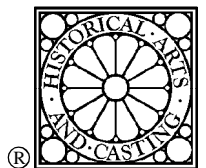

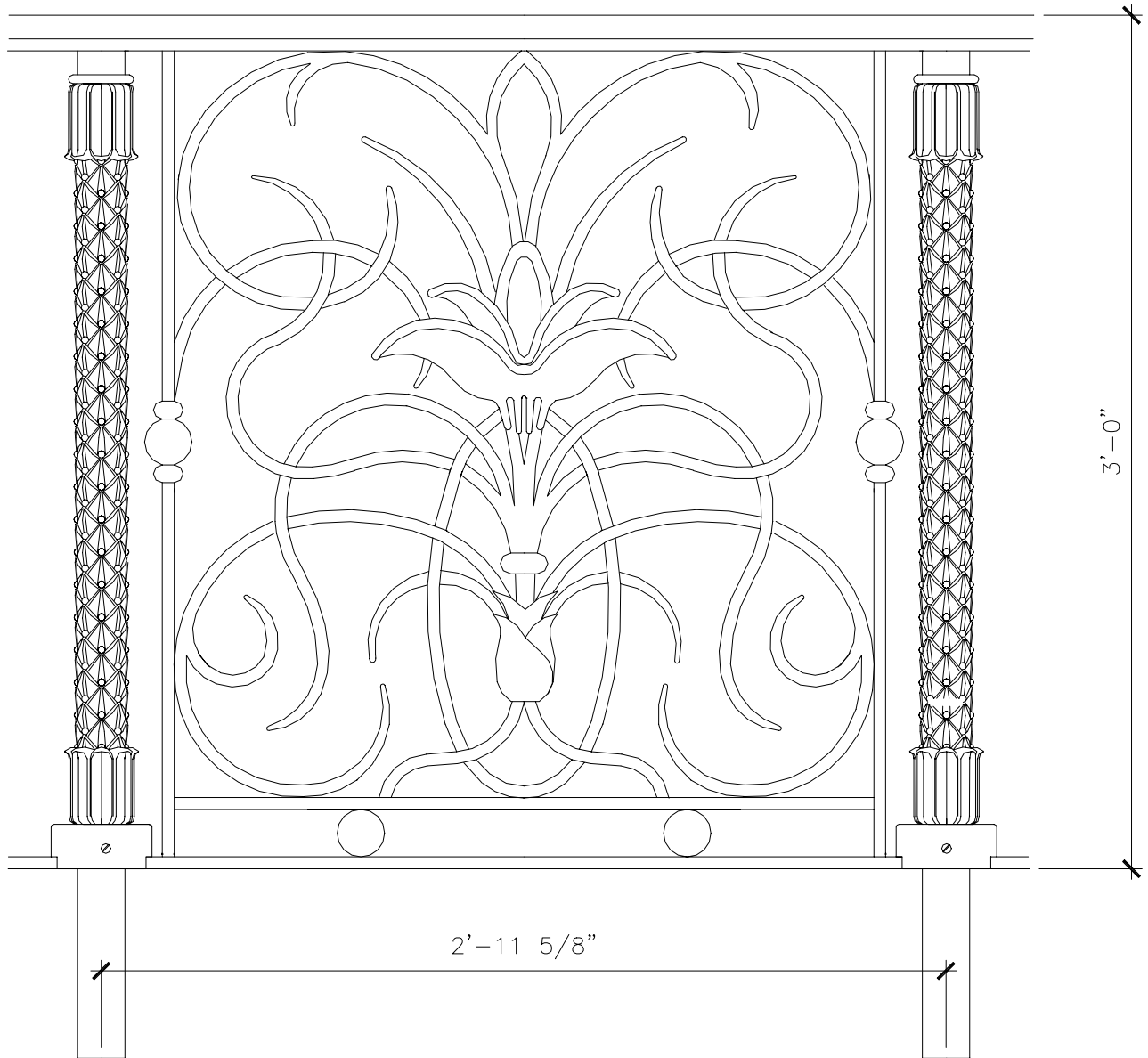

RECOMMENDED MATERIALS

IRON
ALUMINUM
BRONZE

FINISHES

PAINTED
PAINTED, ANTIQUED
PATINA, BRUSHED, HAND RUBBED

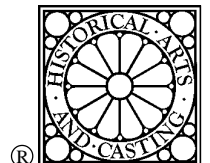

RAILING

RL042A

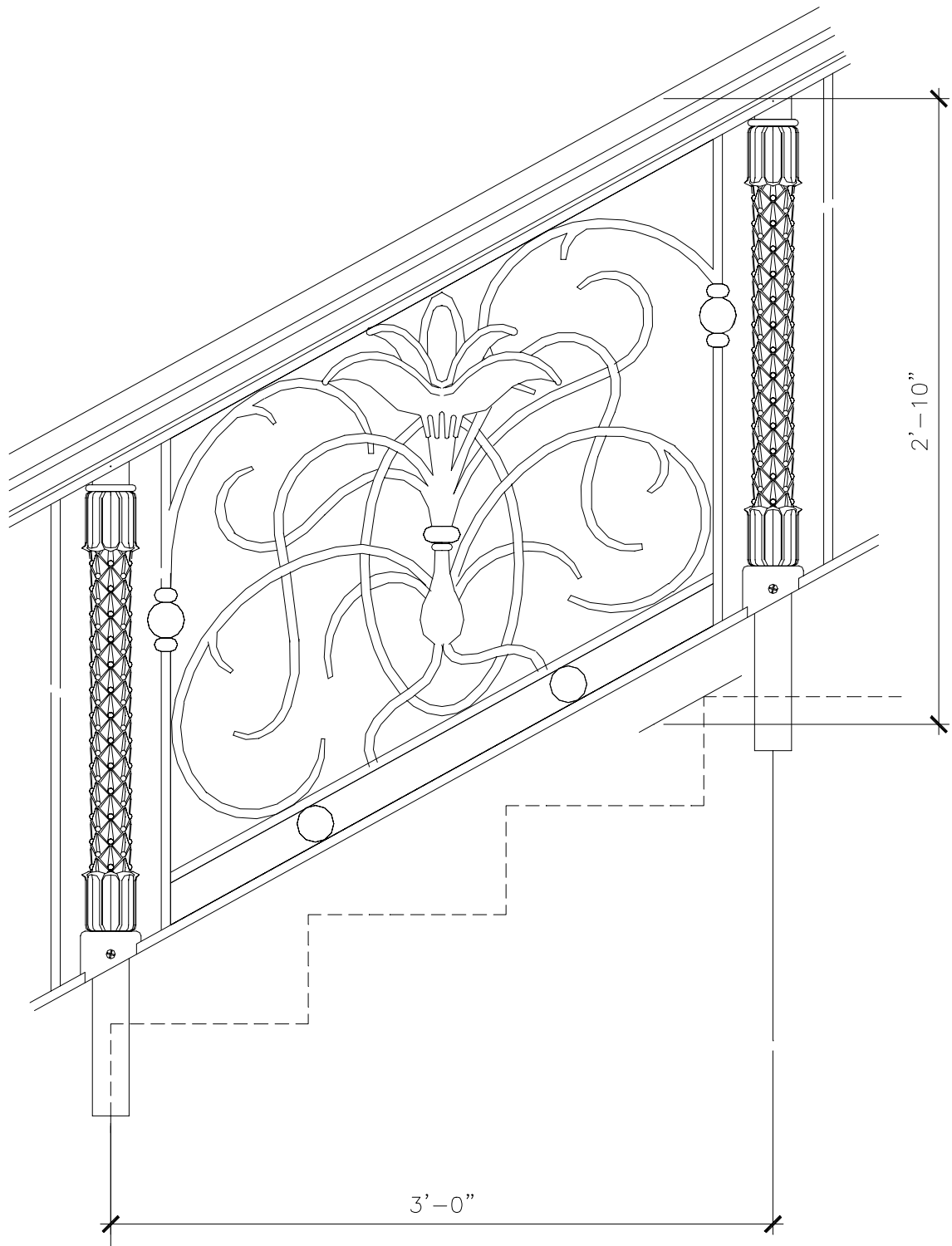

RECOMMENDED MATERIALS

IRON
ALUMINUM
BRONZE

FINISHES

PAINTED
PAINTED, ANTIQUED
PATINA, BRUSHED, HAND RUBBED

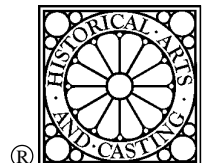

RAILING

RL042A

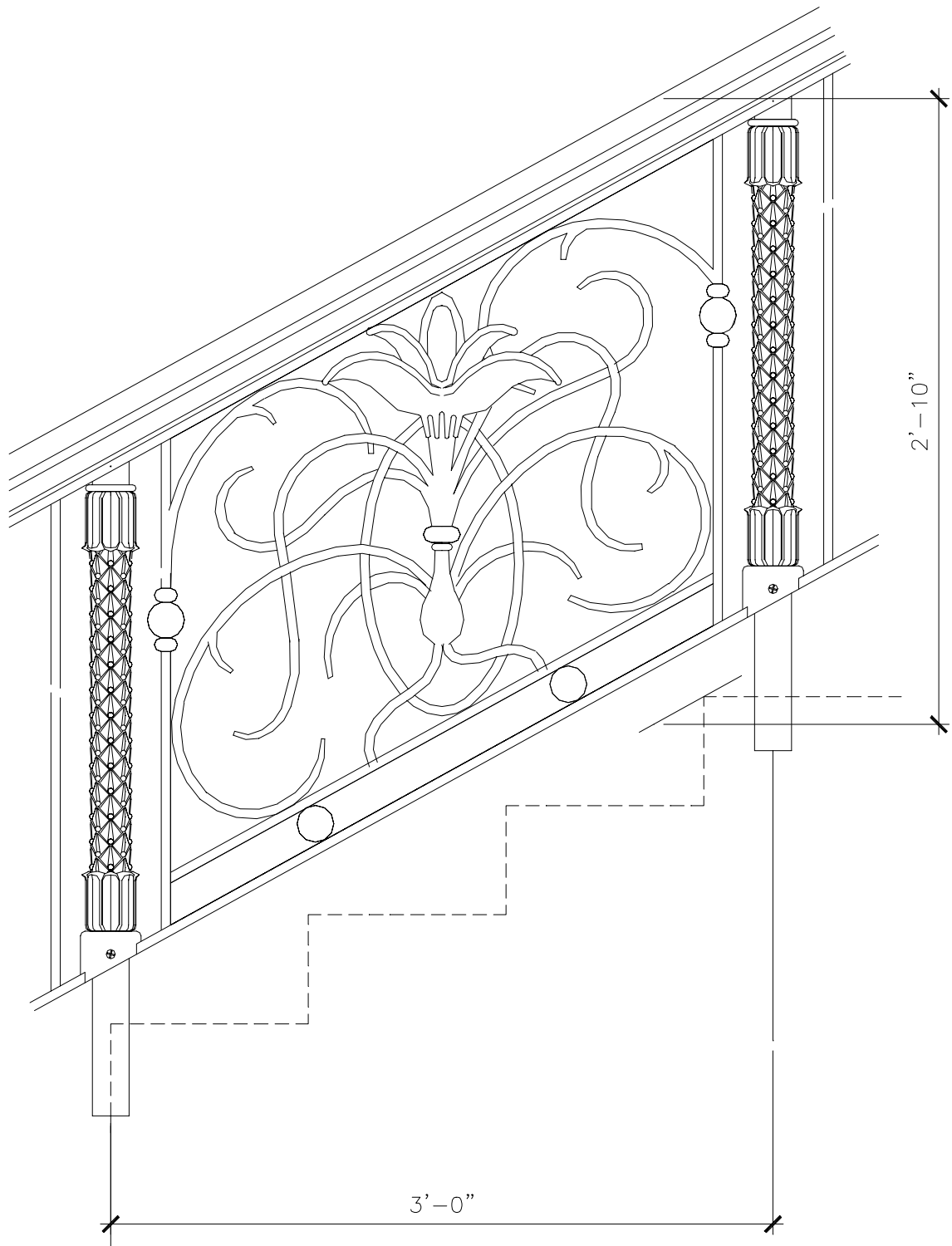

RECOMMENDED MATERIALS

IRON
ALUMINUM
BRONZE

FINISHES

PAINTED
PAINTED, ANTIQUED
PATINA, BRUSHED, HAND RUBBED

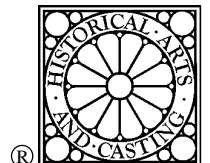

RAILING

RL043

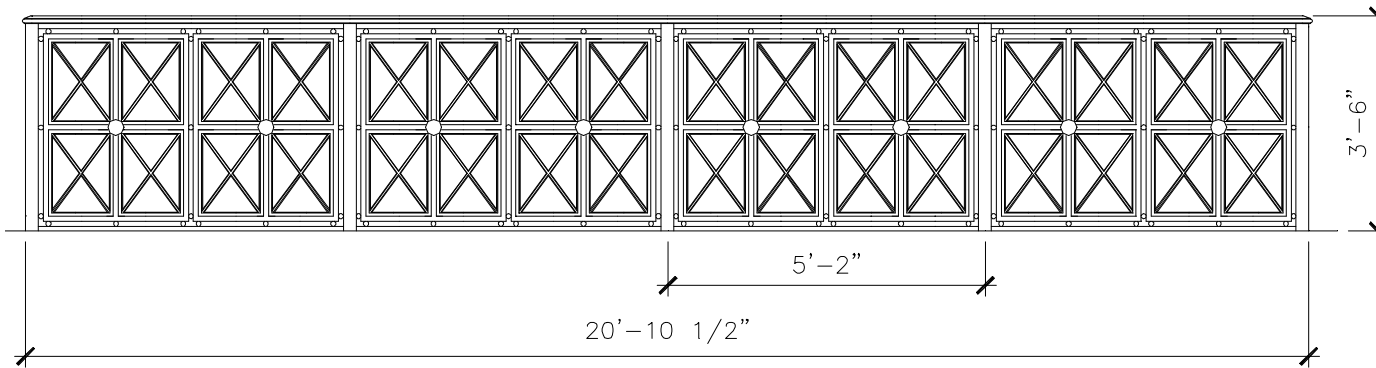
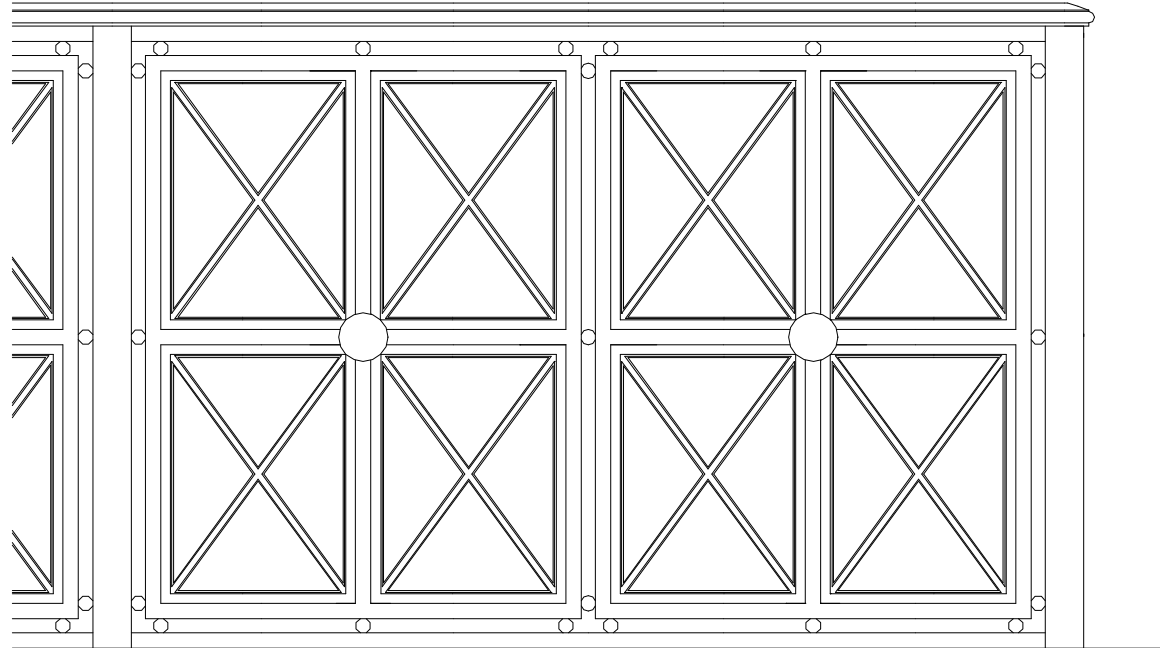

RECOMMENDED MATERIALS

IRON
ALUMINUM
BRONZE

FINISHES

PAINTED
PAINTED, ANTIQUED
PATINA, BRUSHED, HAND RUBBED

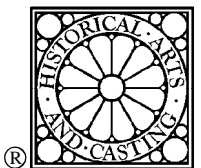

RAILING

RL044

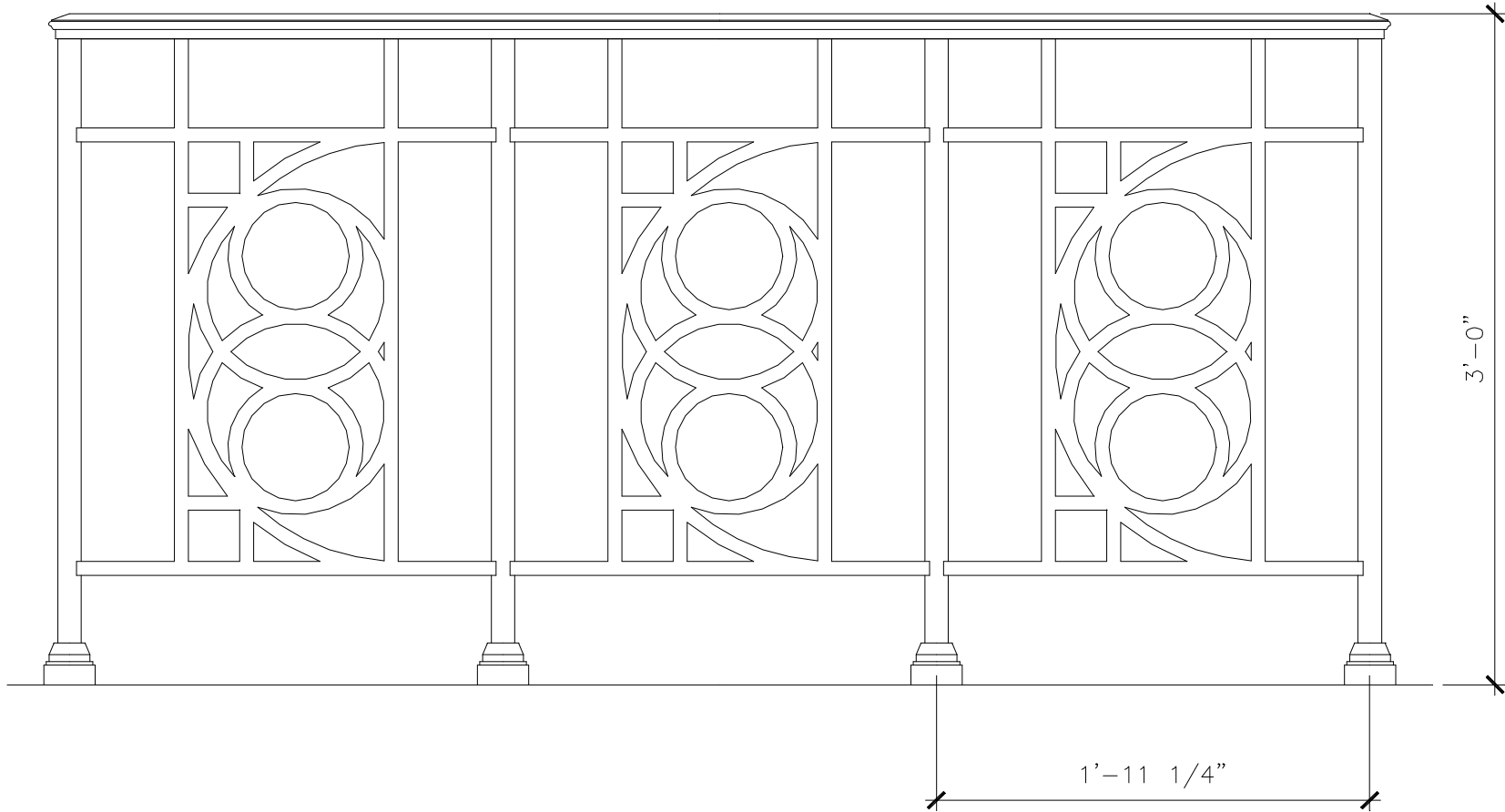

RECOMMENDED MATERIALS

IRON
ALUMINUM
BRONZE

FINISHES

PAINTED
PAINTED, ANTIQUED
PATINA, BRUSHED, HAND RUBBED

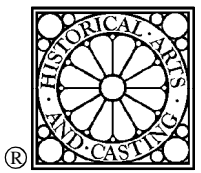

RAILING

RL045

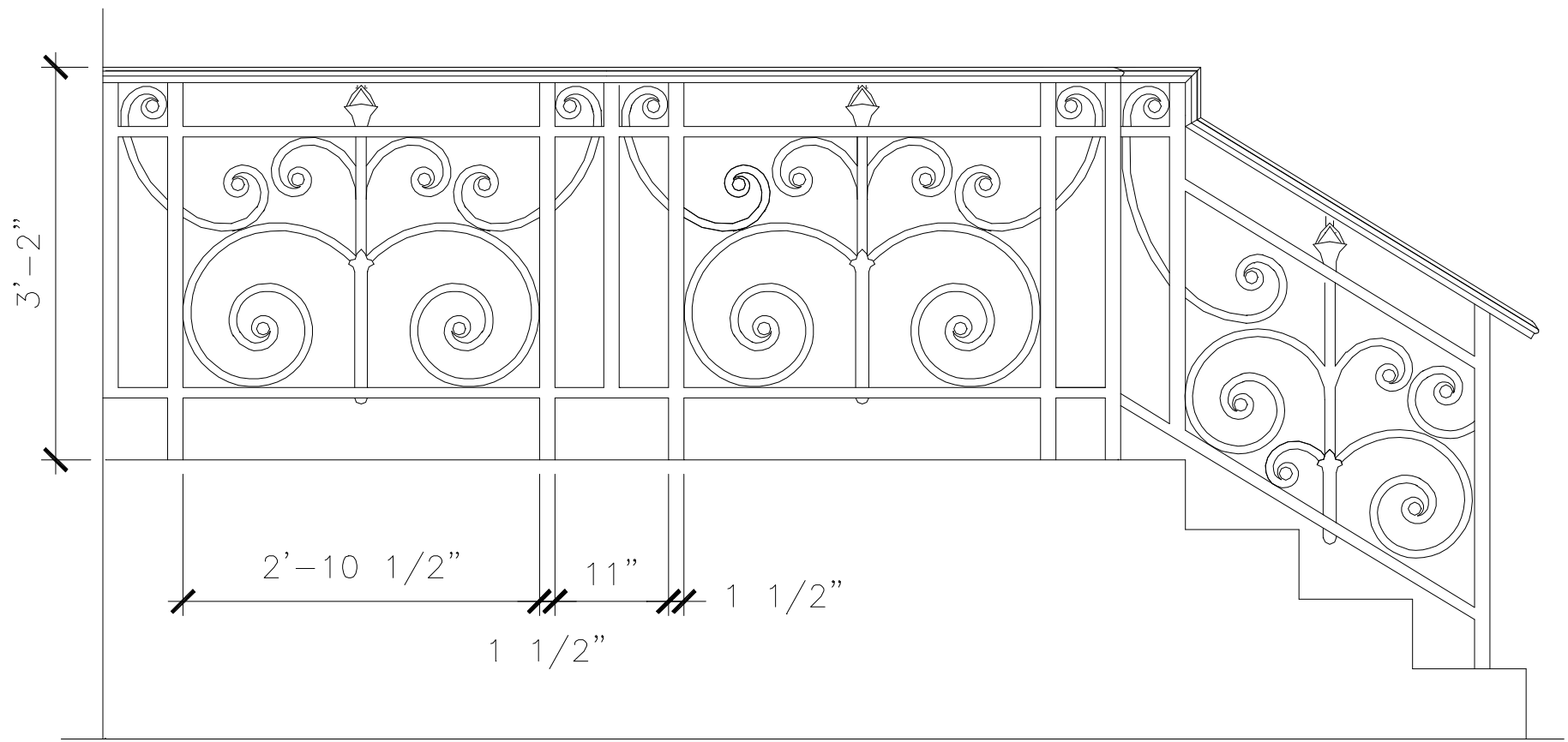

RECOMMENDED MATERIALS

ALUMINUM
BRONZE

FINISHES

PAINTED, ANTIQUED
PATINA, BRUSHED, HAND RUBBED

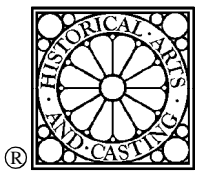

RAILING

RL046

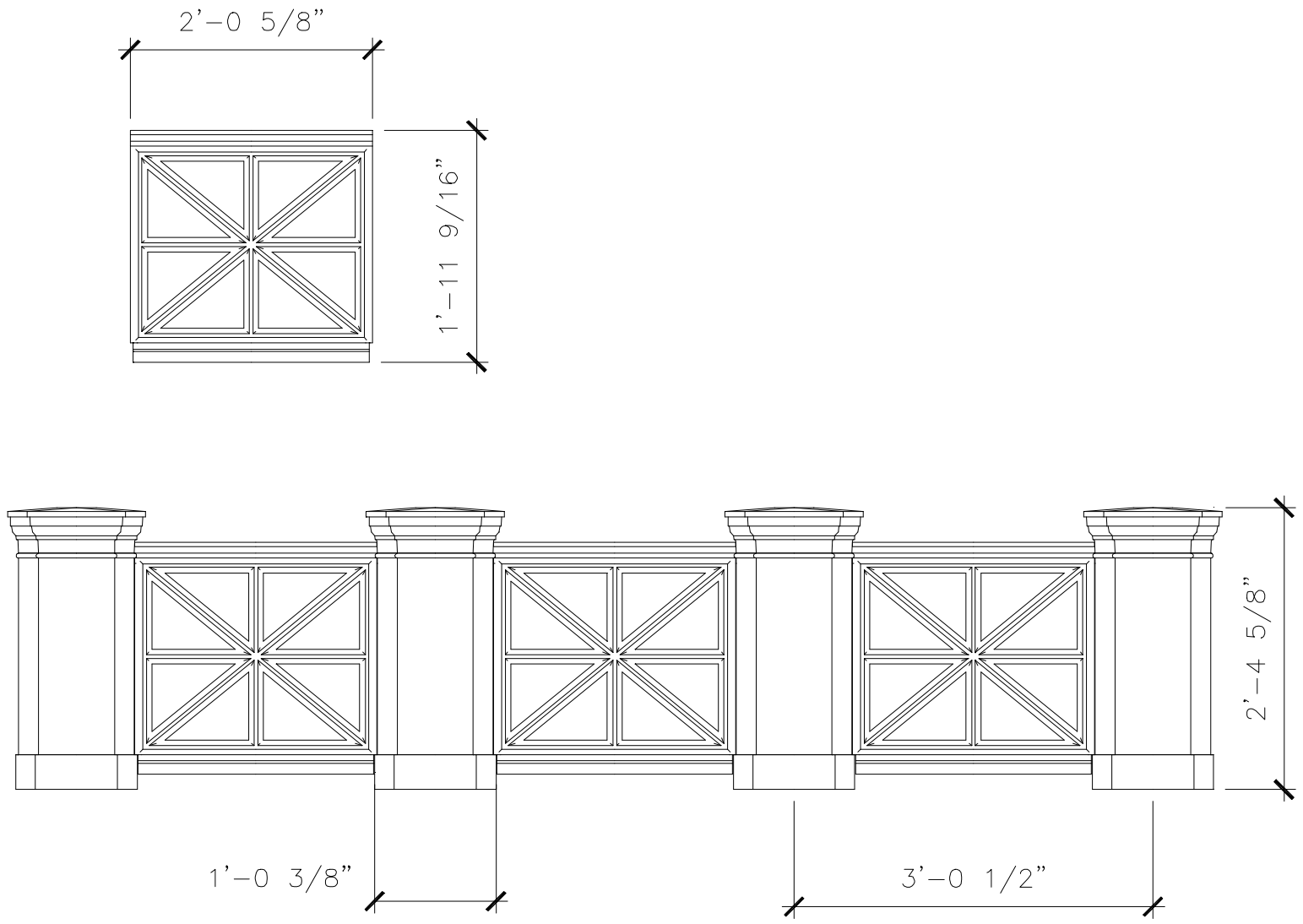

RECOMMENDED MATERIALS

- IRON
- ALUMINUM
- BRONZE

FINISHES

- PAINTED
- PAINTED, ANTIQUED
- PATINA, BRUSHED, HAND RUBBED

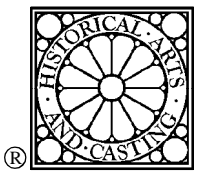

BALUSTER

RL047

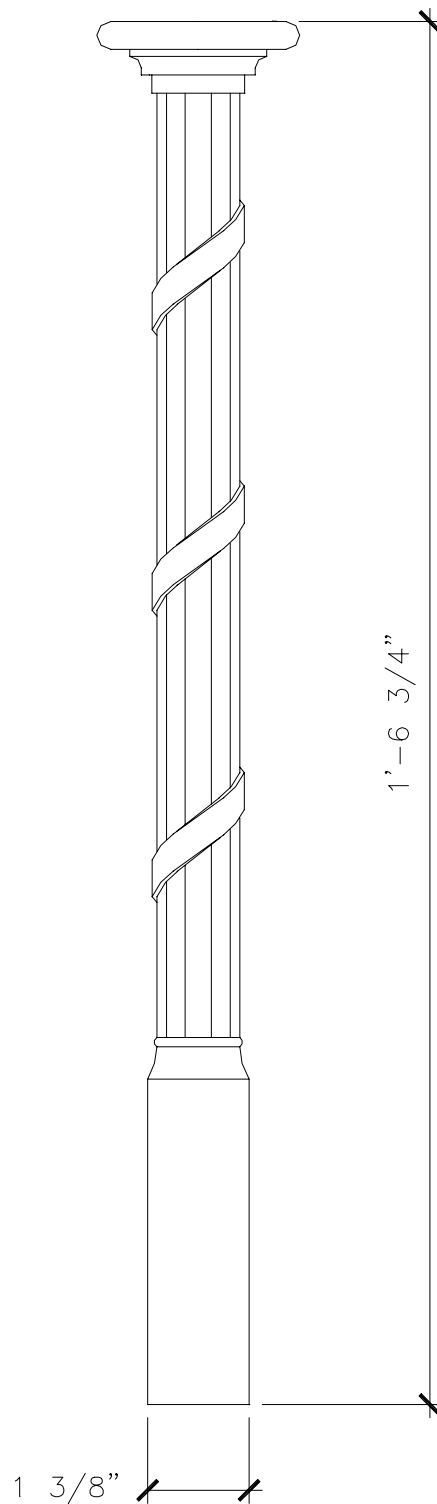

RECOMMENDED MATERIALS

ALUMINUM
BRONZE

FINISHES

PAINTED, ANTIQUED
PATINA, BRUSHED, HAND RUBBED



RAILING

RL048

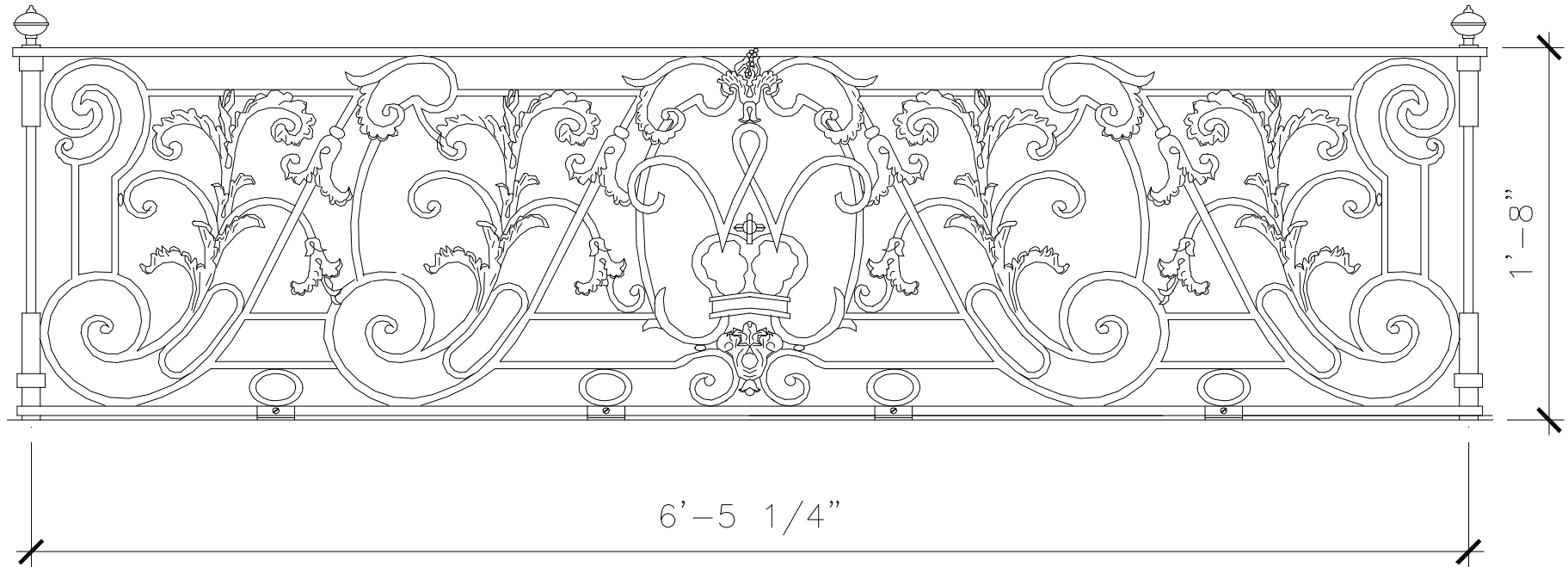

RECOMMENDED MATERIALS

ALUMINUM
BRONZE

FINISHES

PAINTED, ANTIQUED
PATINA, BRUSHED, HAND RUBBED

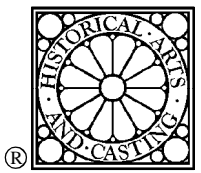

RAILING

RL049

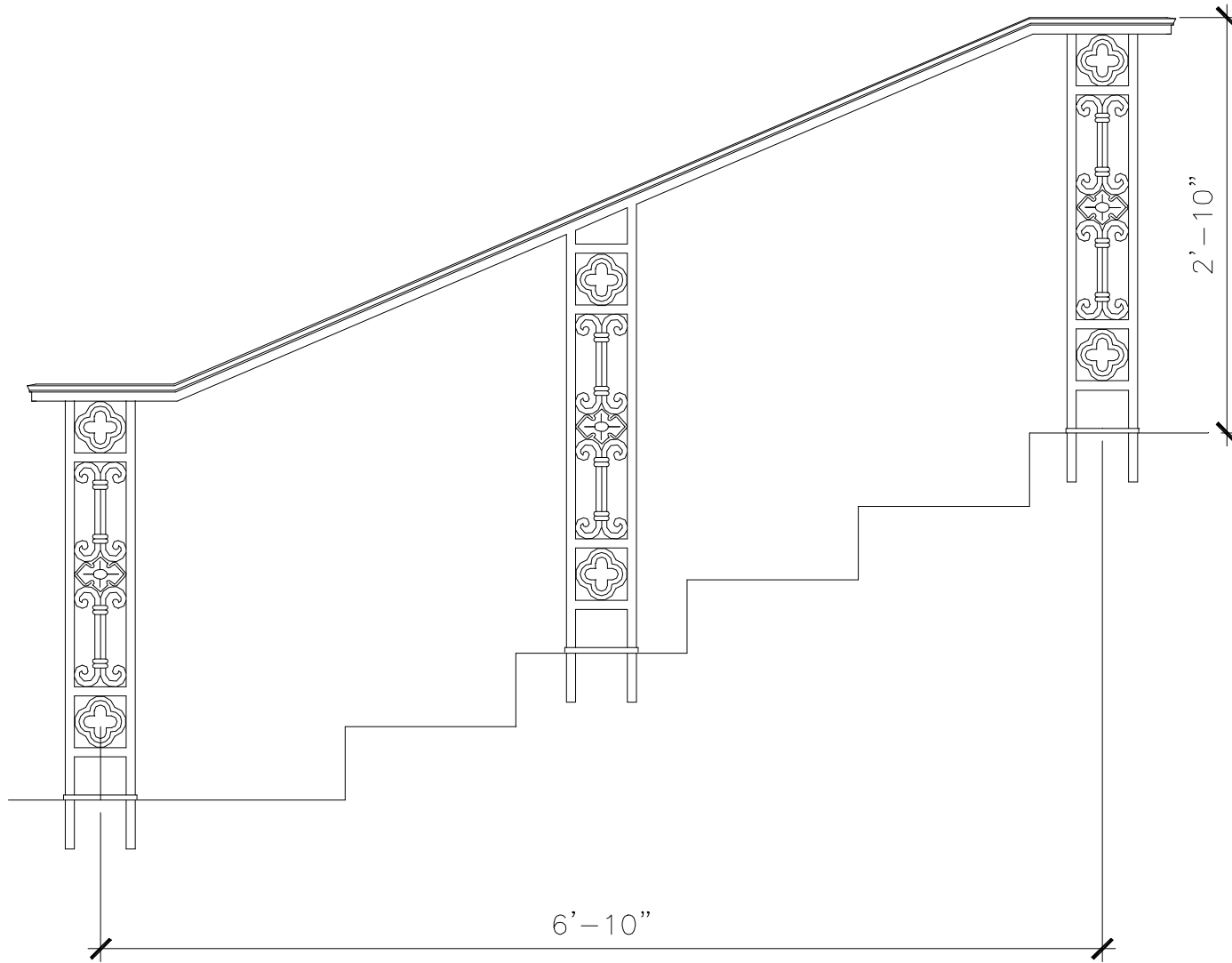

RECOMMENDED MATERIALS

IRON
ALUMINUM
BRONZE

FINISHES

PAINTED
PAINTED, ANTIQUED
PATINA, BRUSHED, HAND RUBBED

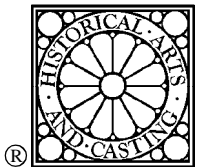

NEWEL POST

RL050

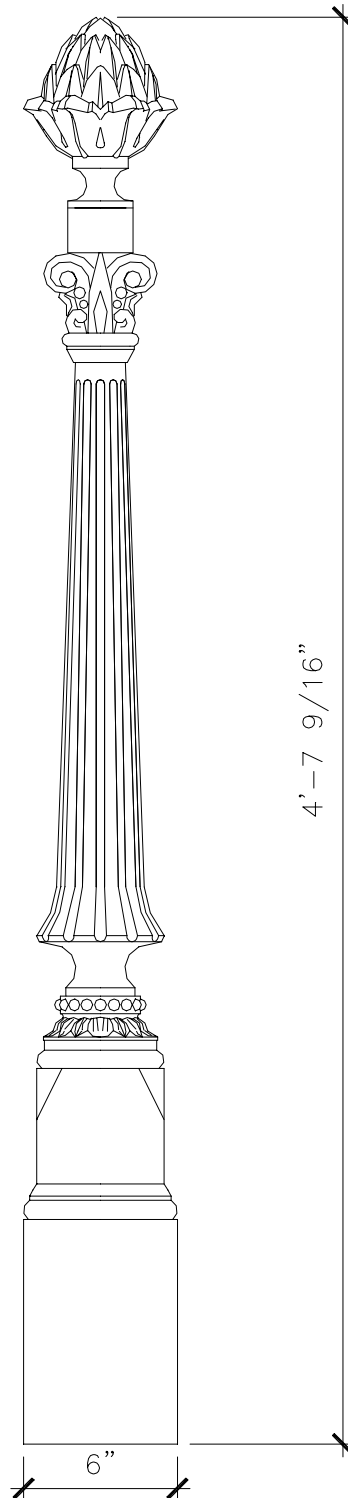

RECOMMENDED MATERIALS

ALUMINUM
BRONZE

FINISHES

PAINTED, ANTIQUED
PATINA, BRUSHED, HAND RUBBED



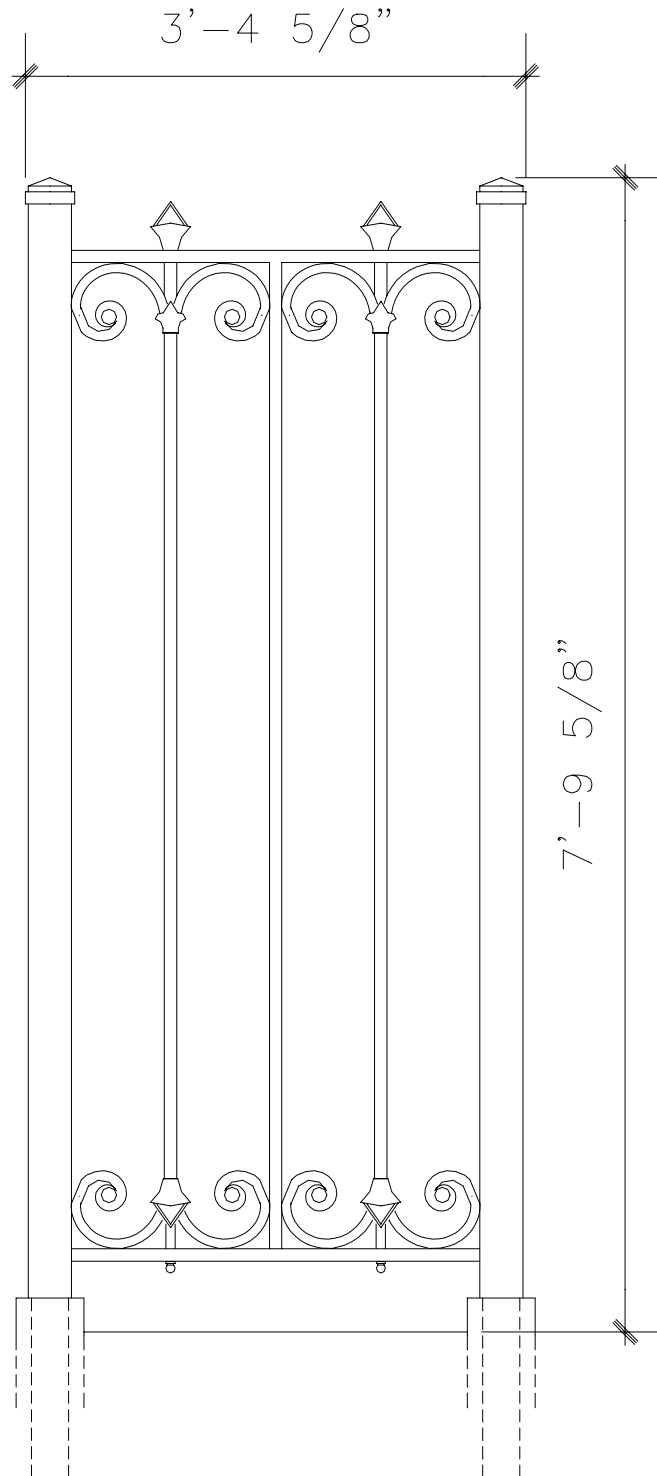

RECOMMENDED MATERIALS

ALUMINUM
BRONZE

FINISHES

PAINTED, ANTIQUED
PATINA, BRUSHED, HAND RUBBED

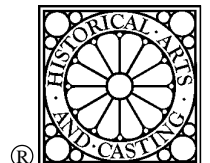

RAILING

RL052

6'-9 3/4"

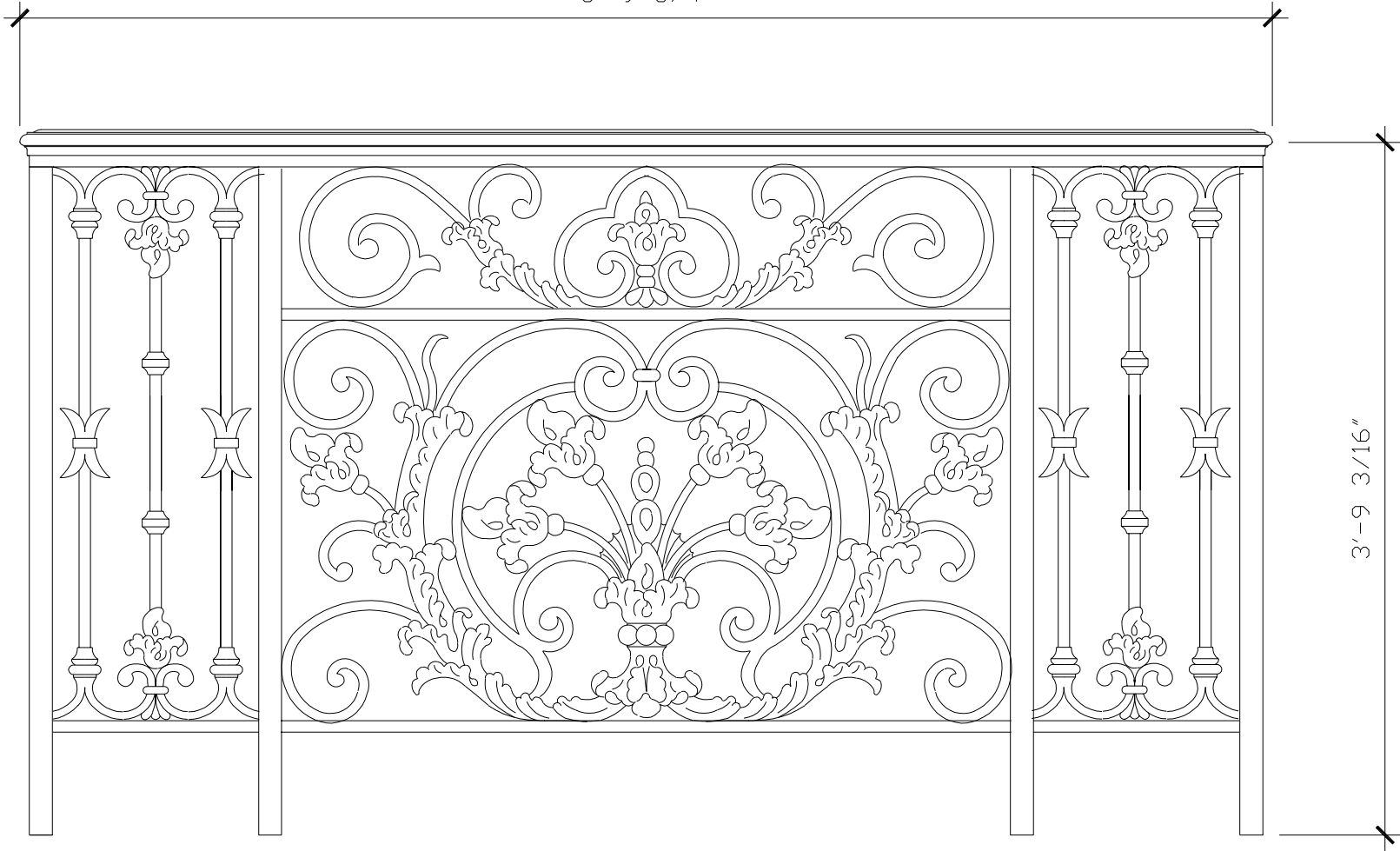

3'-9 3/16"

RECOMMENDED MATERIALS

ALUMINUM
BRONZE

FINISHES

PAINTED, ANTIQUED
PATINA, BRUSHED, HAND RUBBED

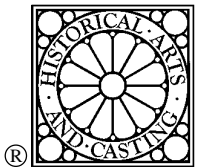

RAILING

RL053

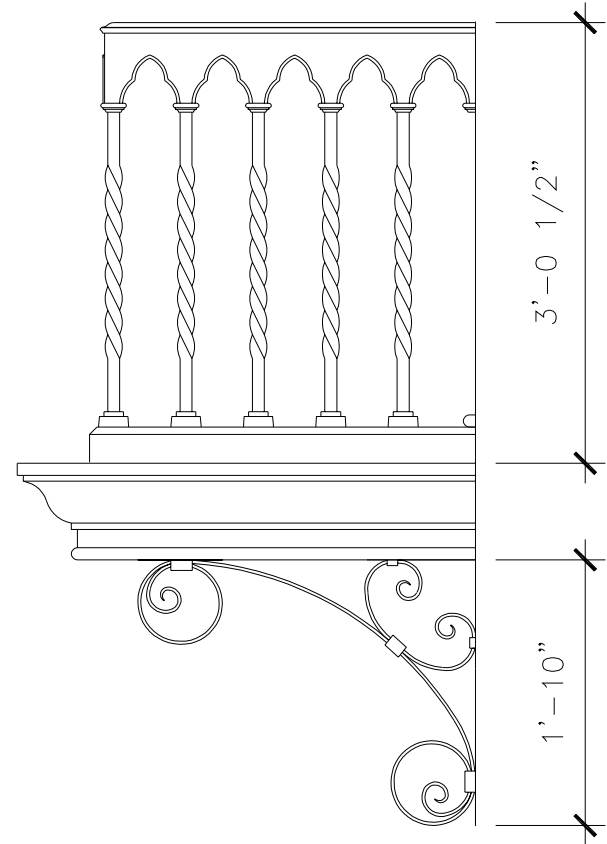
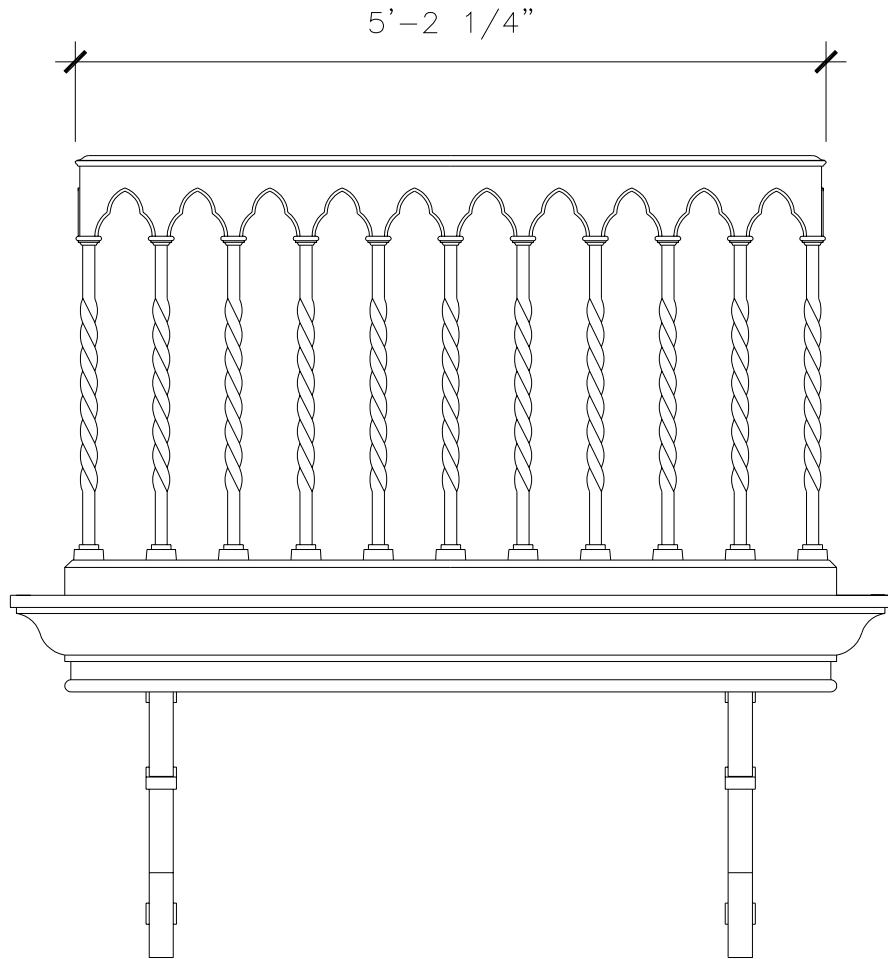

RECOMMENDED MATERIALS

ALUMINUM
BRONZE

FINISHES

PAINTED, ANTIQUED
PATINA, BRUSHED, HAND RUBBED

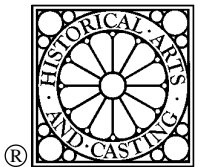

RAILING

RL055

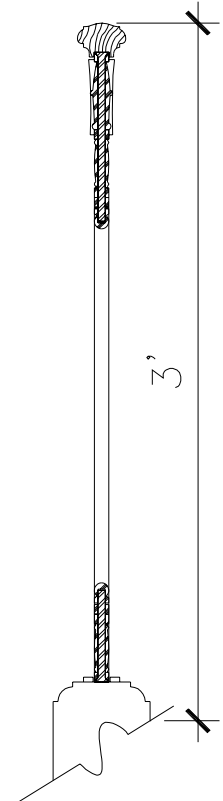
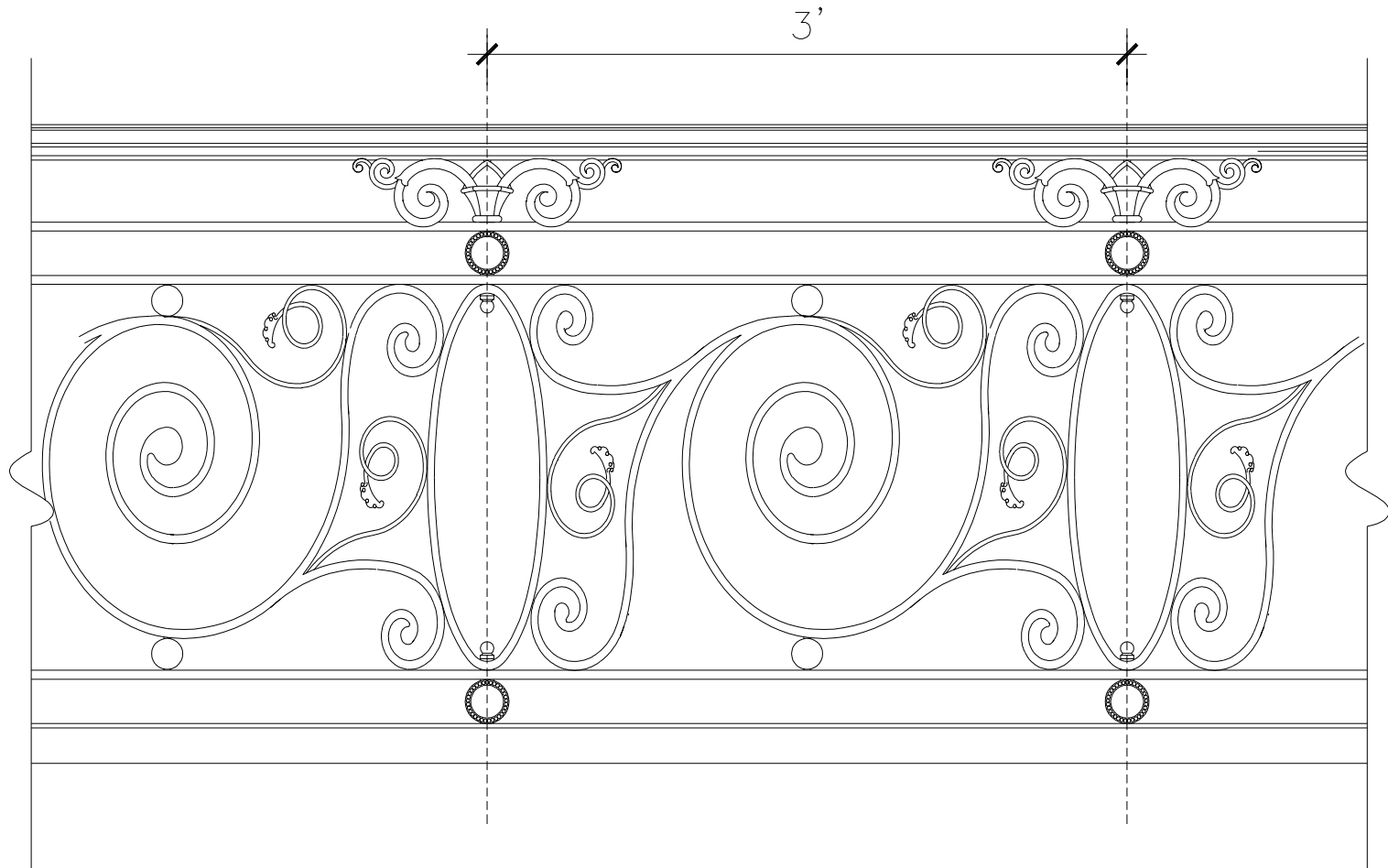

RECOMMENDED MATERIALS

ALUMINUM
BRONZE

FINISHES

PAINTED, ANTIQUED
PATINA, BRUSHED, HAND RUBBED

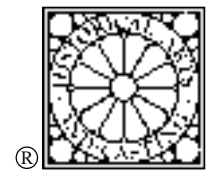

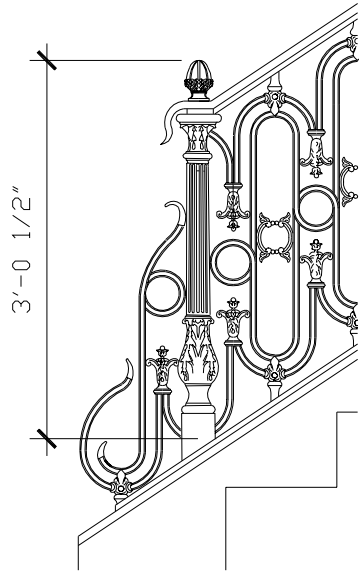

SECTION A

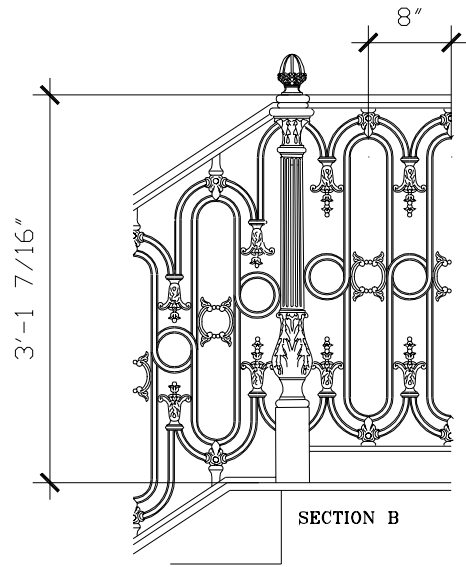

SECTION B

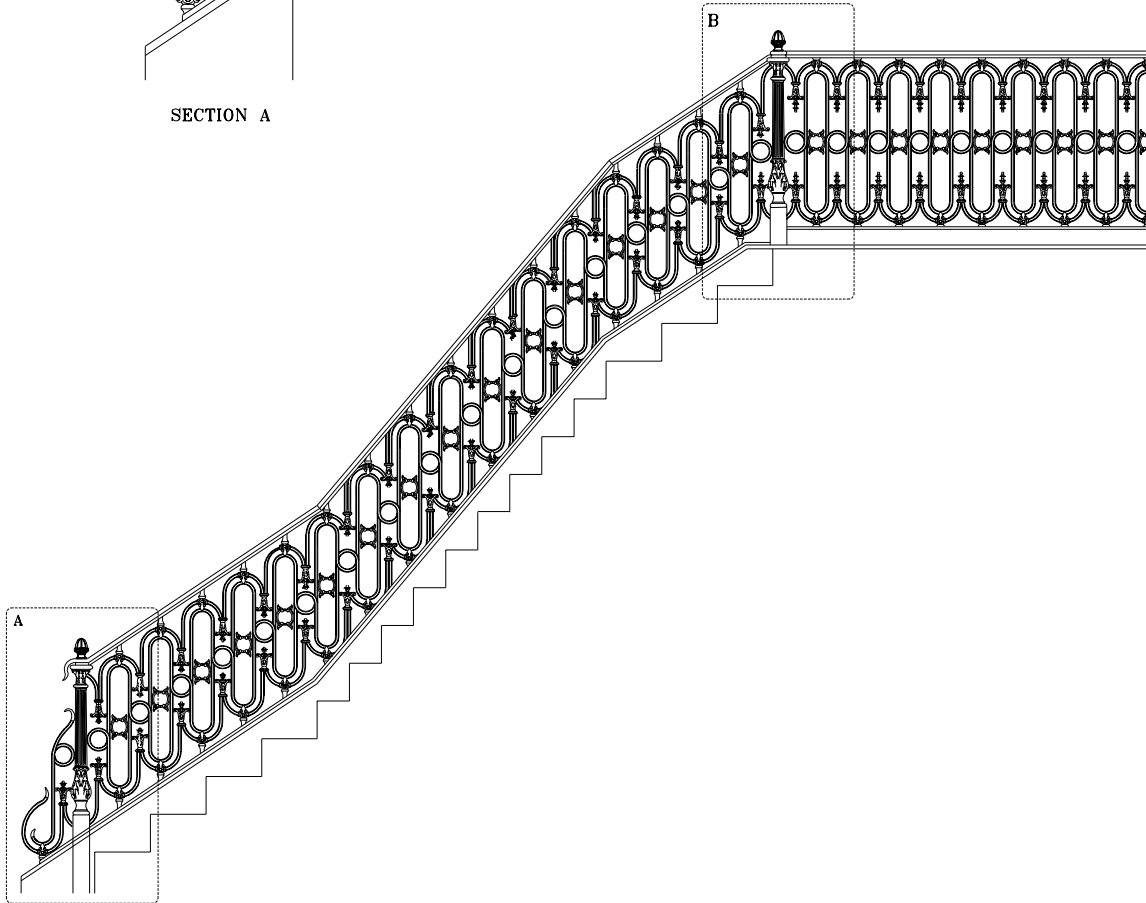

RECOMMENDED MATERIALS

IRON
ALUMINUM
BRONZE

FINISHES

PAINTED
PAINTED, ANTIQUED
PATINA, BRUSHED, HAND RUBBED

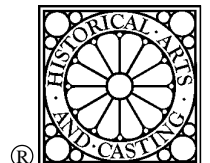

RAILING

RL057

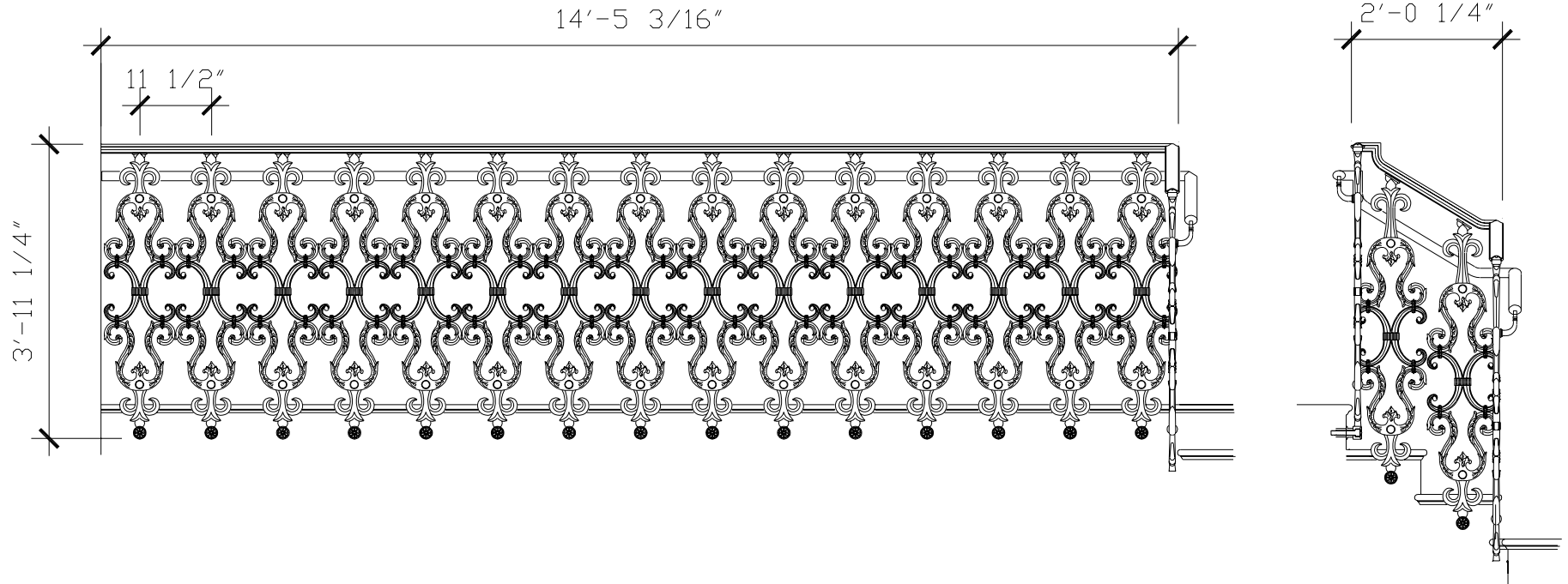

RECOMMENDED MATERIALS

ALUMINUM
BRONZE

FINISHES

PAINTED, ANTIQUED
PATINA, BRUSHED, HAND RUBBED

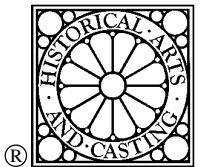

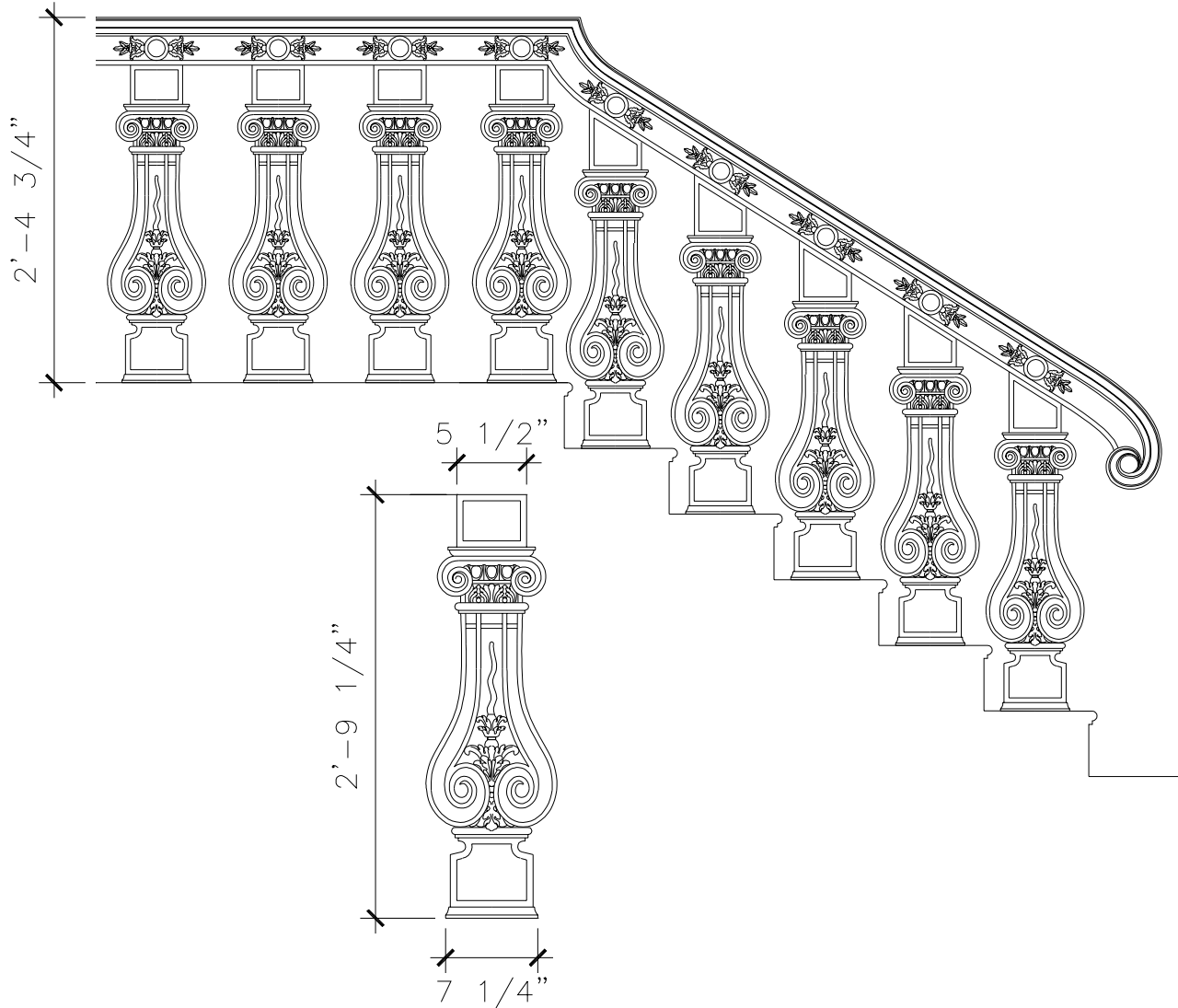

RECOMMENDED MATERIALS

IRON
ALUMINUM

FINISHES

PAINTED
PAINTED, ANTIQUED

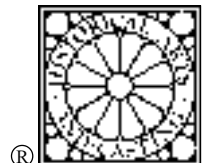

®

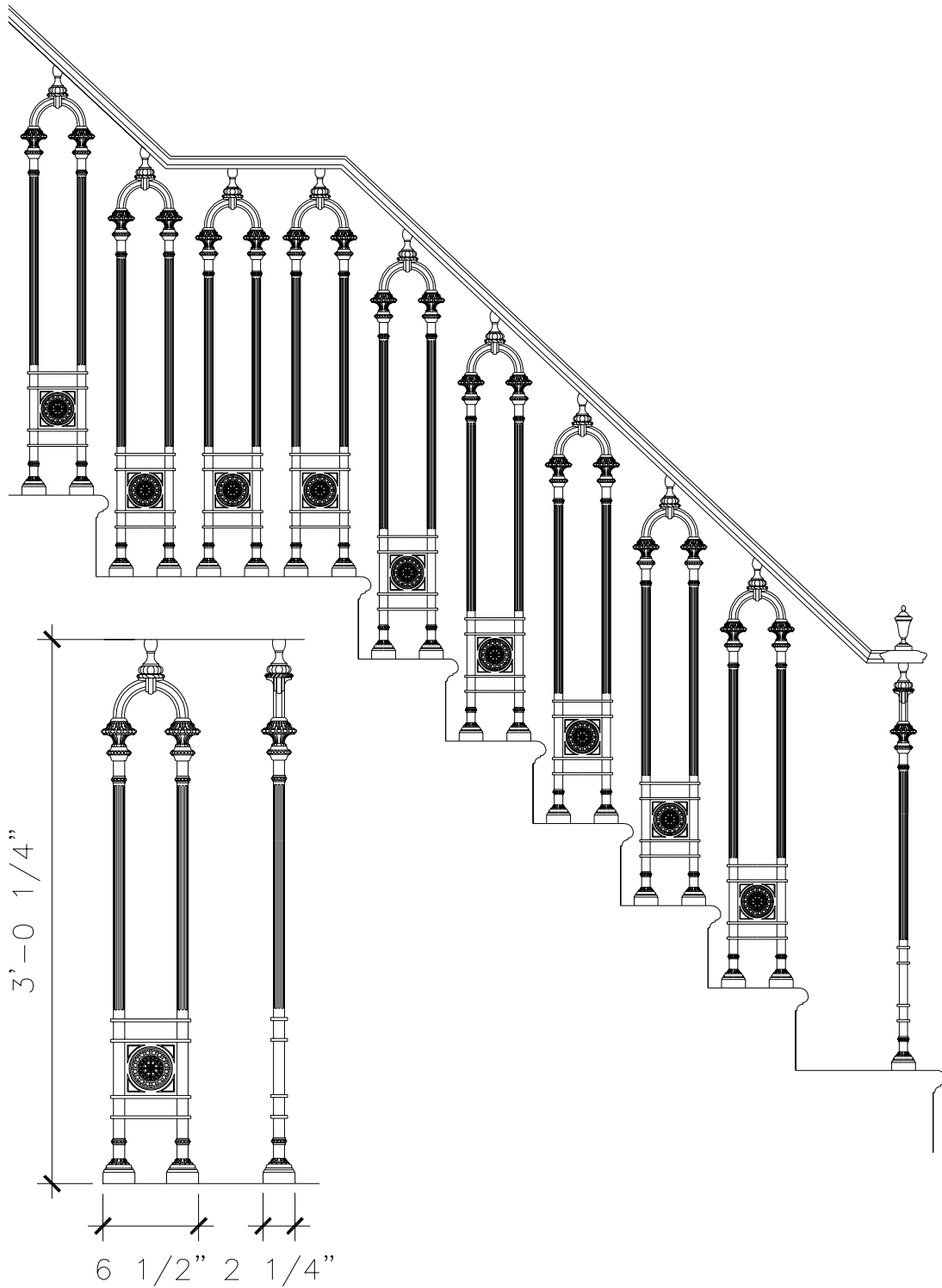

RECOMMENDED MATERIALS

IRON
ALUMINUM

FINISHES

PAINTED
PAINTED, ANTIQUED

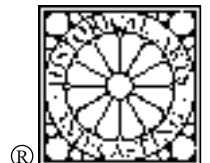

RAILING

RL060

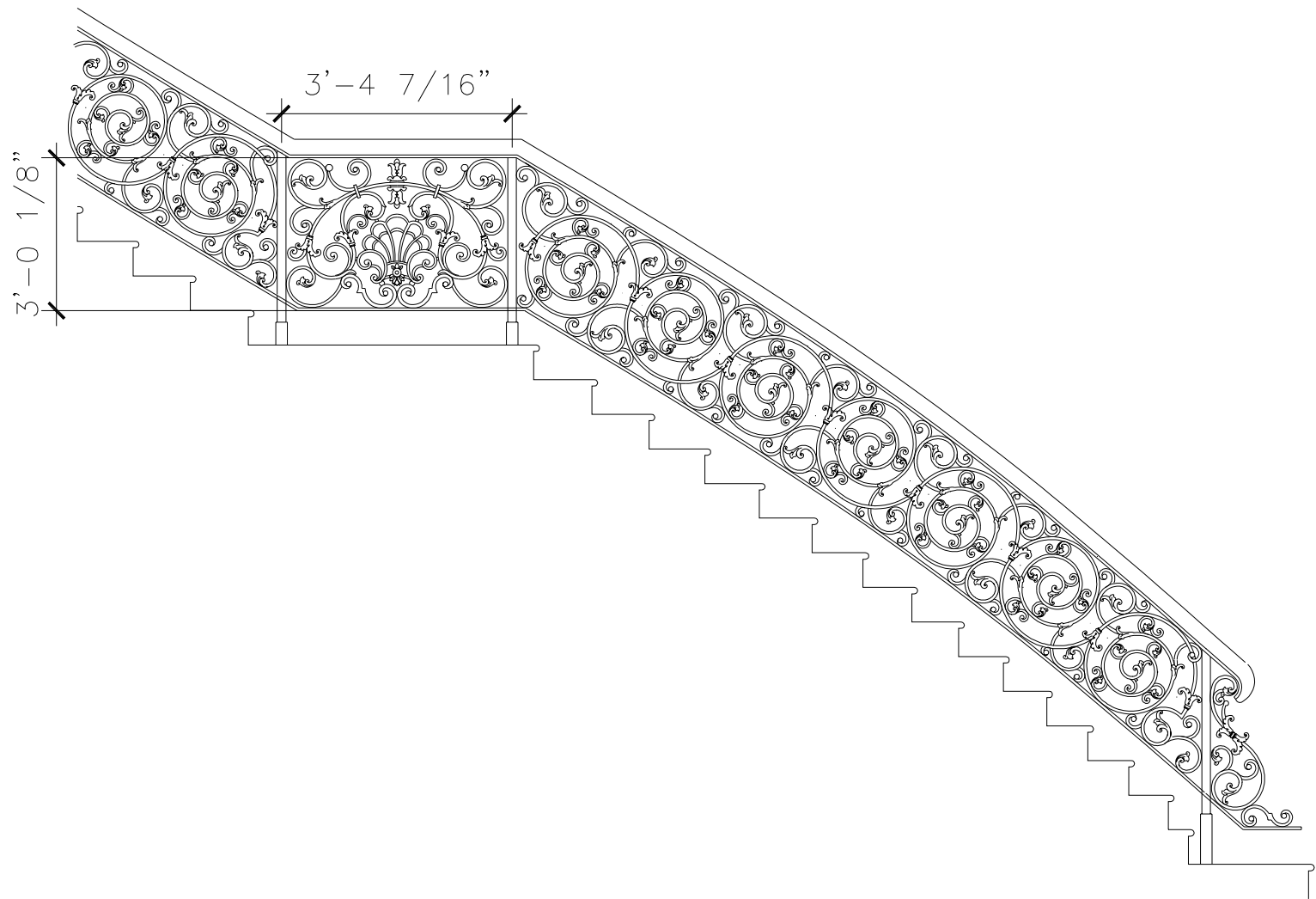

RECOMMENDED MATERIALS

ALUMINUM
BRONZE

FINISHES

PAINTED, ANTIQUED
PATINA, BRUSHED, HAND RUBBED

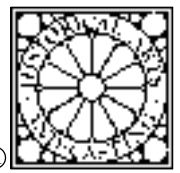

®

RAILING

RL061

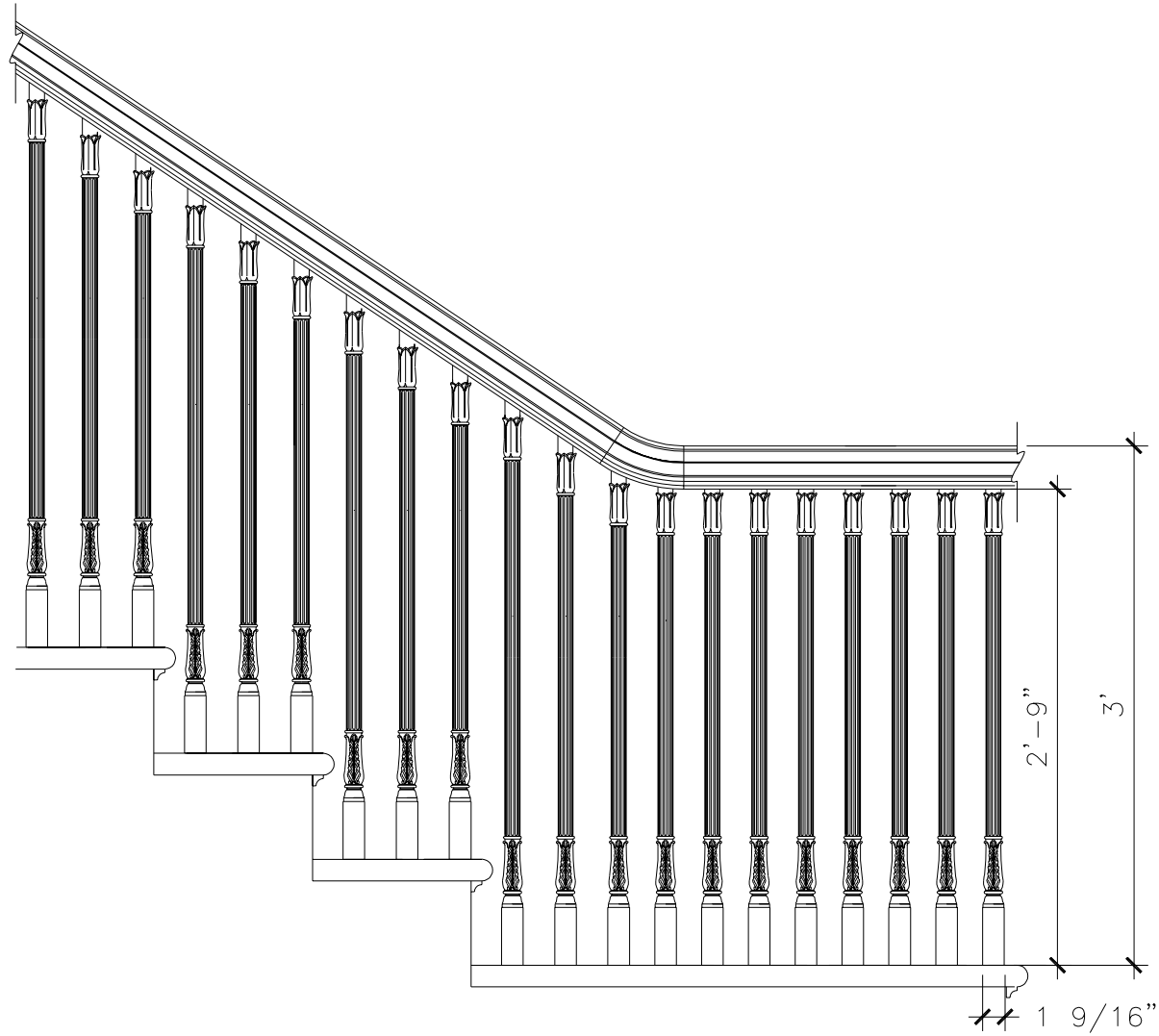

RECOMMENDED MATERIALS

ALUMINUM
BRONZE

FINISHES

PAINTED, ANTIQUED
PATINA, BRUSHED, HAND RUBBED

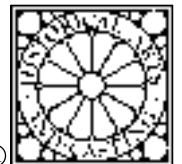

®

RAILING

RL062

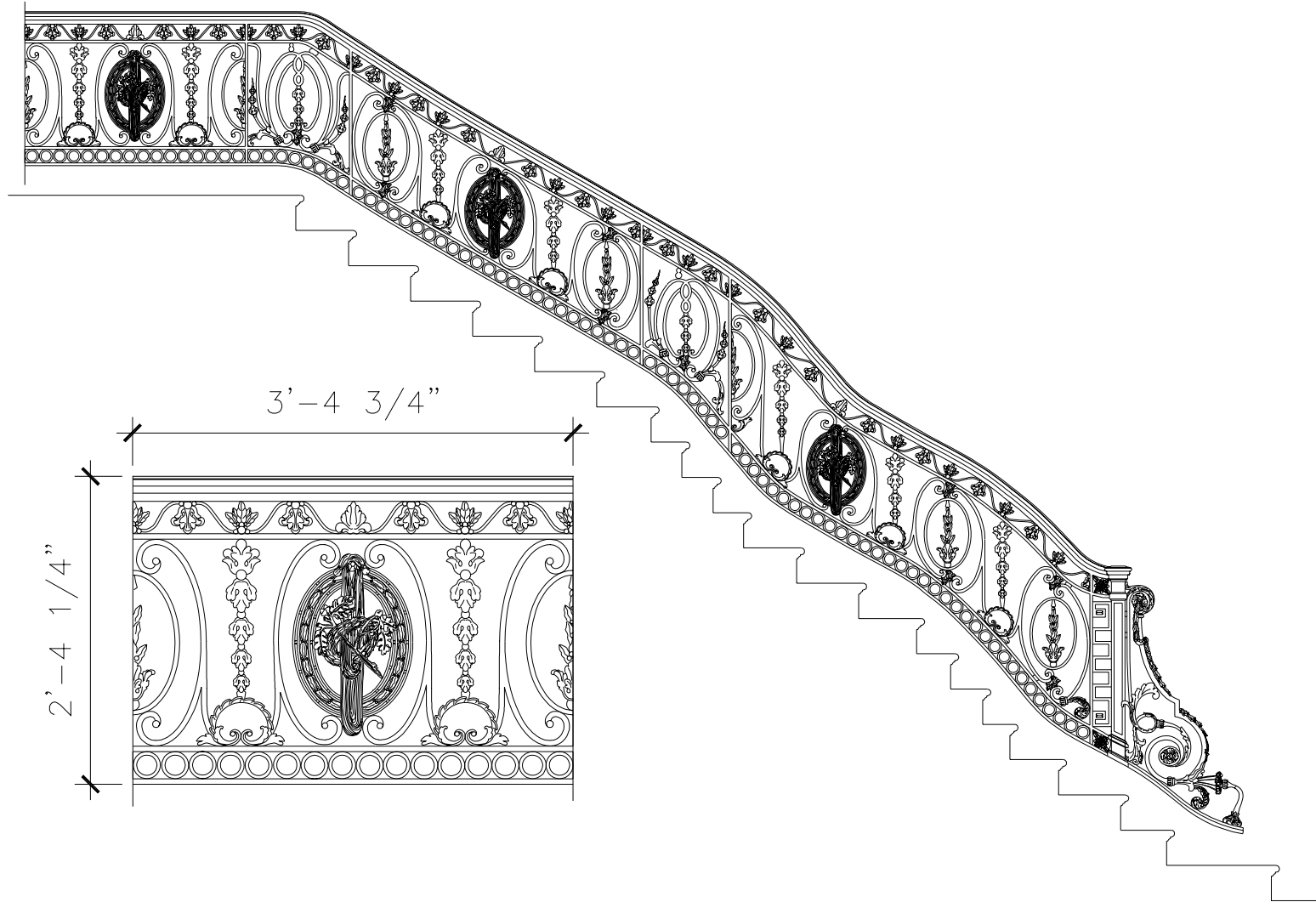

RECOMMENDED MATERIALS

IRON
ALUMINUM
BRONZE

FINISHES

PAINTED
PAINTED, ANTIQUED
PATINA, BRUSHED, HAND RUBBED

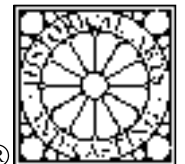

RAILING

RL063

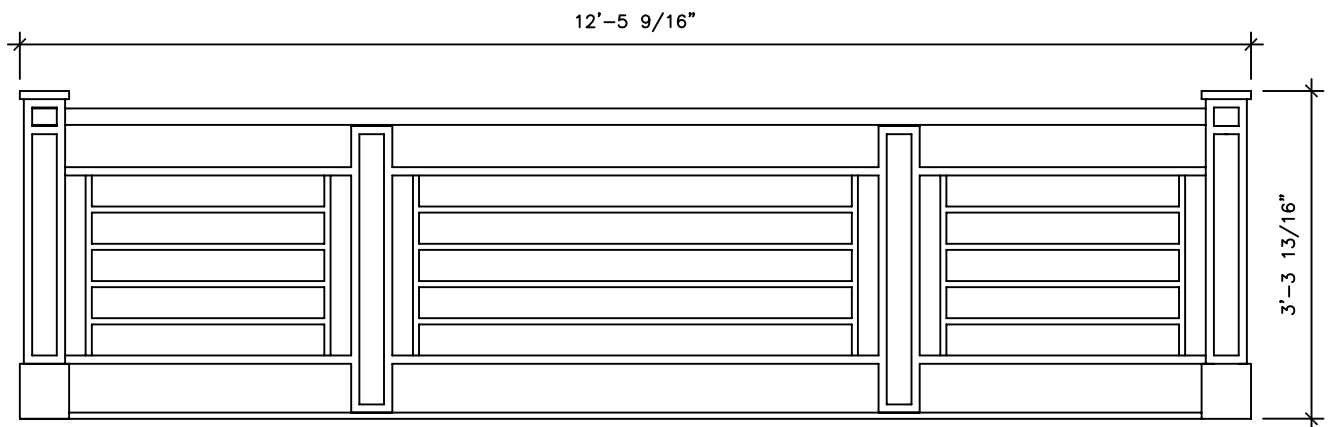
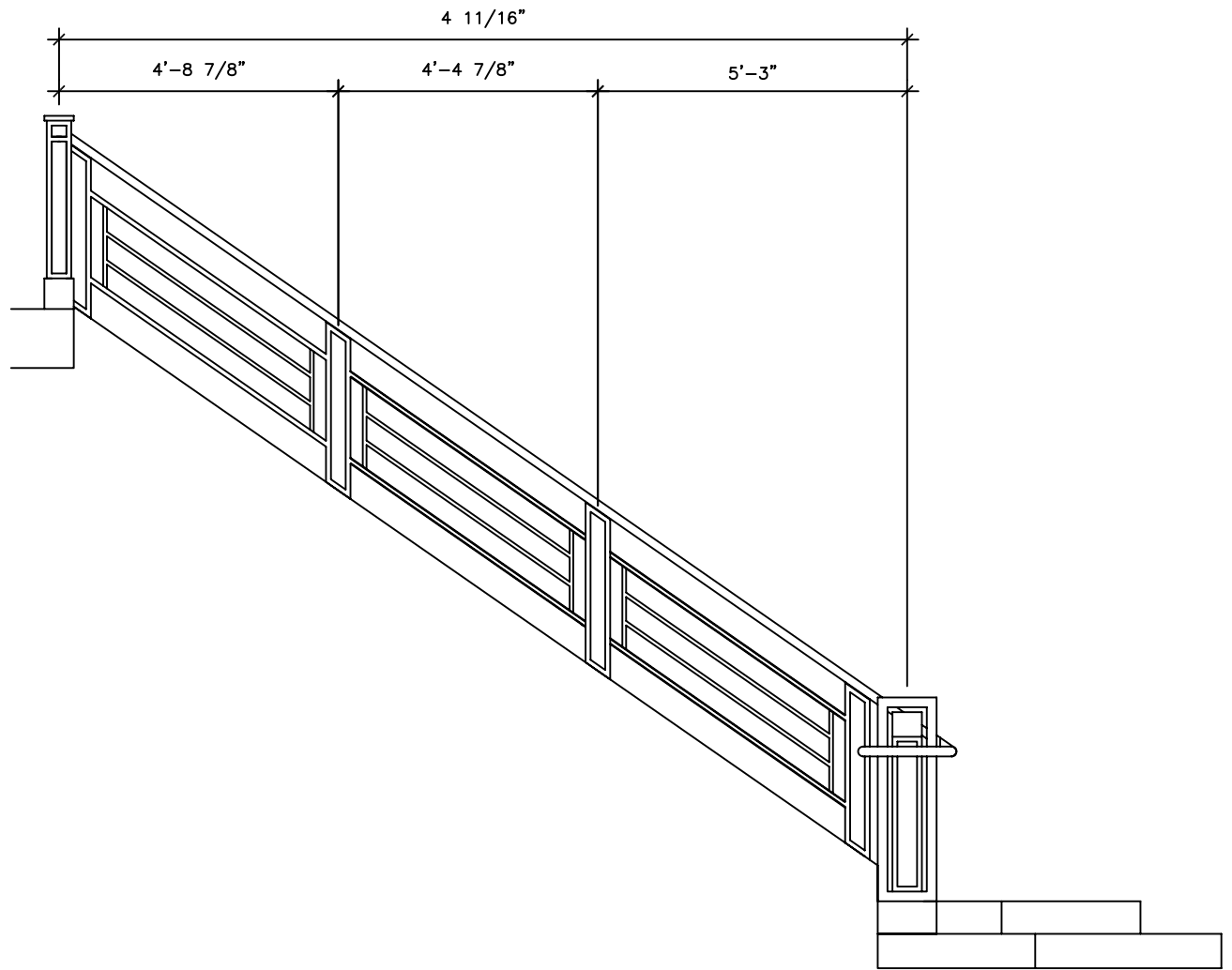

RECOMMENDED MATERIALS
ALUMINIUM, BRONZE, IRON

FINISHES
PAINTED, PATINA, BRUSHED



®

RAILING

RL064

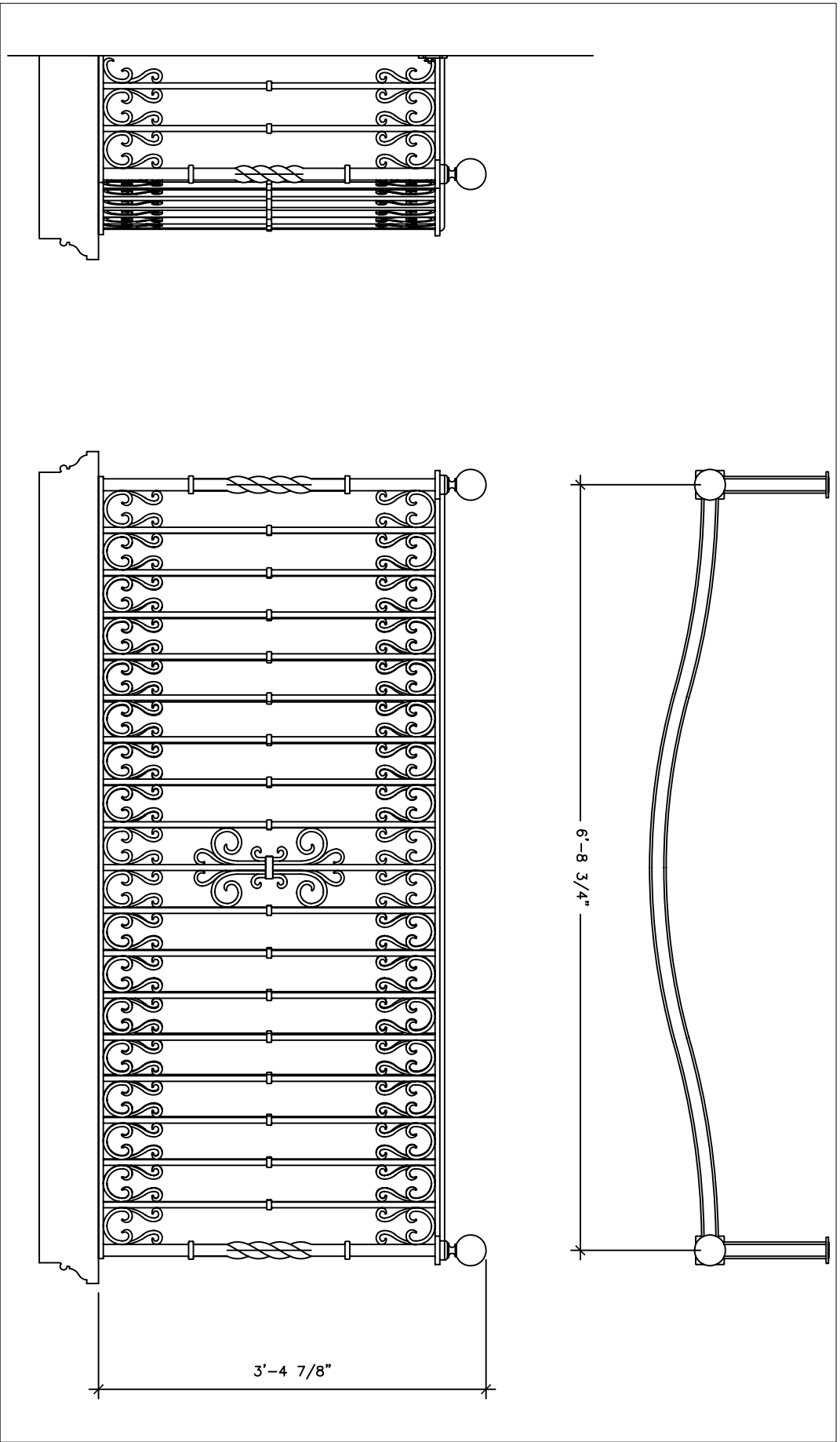

RECOMMENDED MATERIALS
IRON, ALUMINUM, BRONZE

FINISHES
PAINTED, ANTIQUED, PATINA, BRUSHED, HAND RUBBED



Design Credit:

Historical Arts & Casting, Inc. · 5580 West Bagley Park Road · West Jordan, Utah 84088 · (801) 280-2400 · www.historicalarts.com

RAILING

RL065

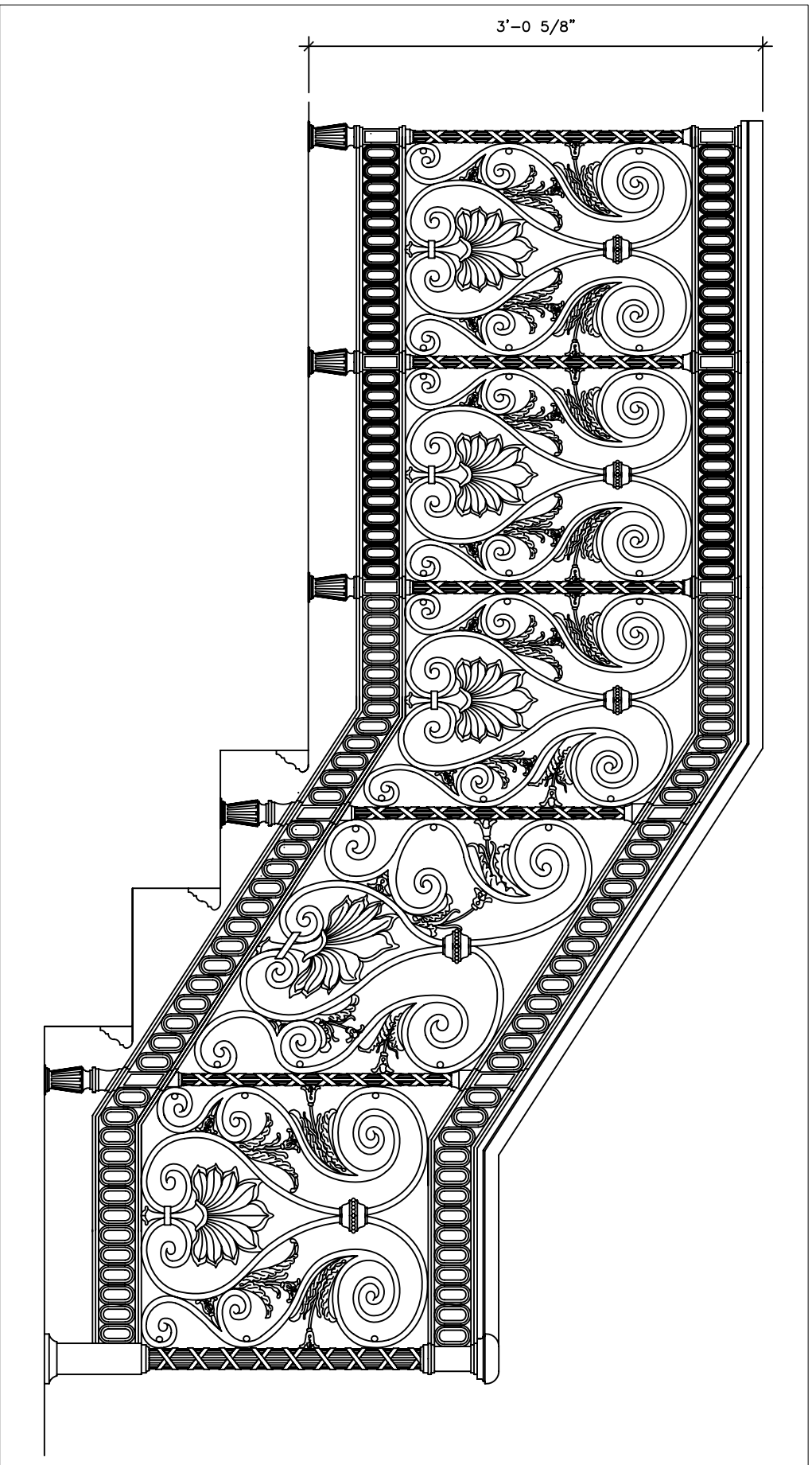

RECOMMENDED MATERIALS

IRON, ALUMINIUM, BRONZE

FINISHES

PAINTED, ANTIQUED, PATINA, BRUSHED, HAND RUBBED

Design Credit:

Historical Arts & Casting, Inc. · 5580 West Bagley Park Road · West Jordan, Utah 84088 · (801) 280-2400 · www.historicalarts.com



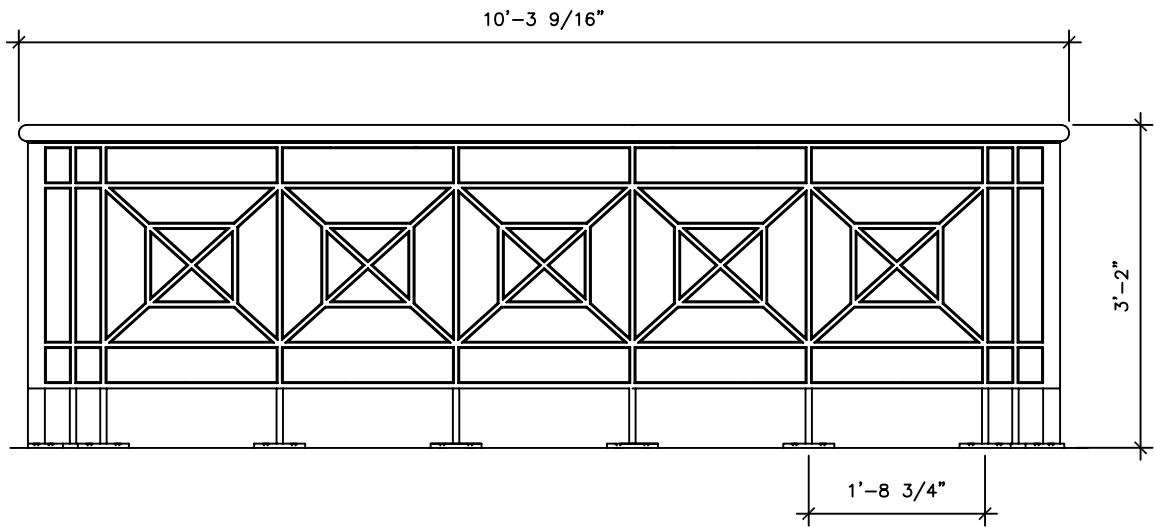
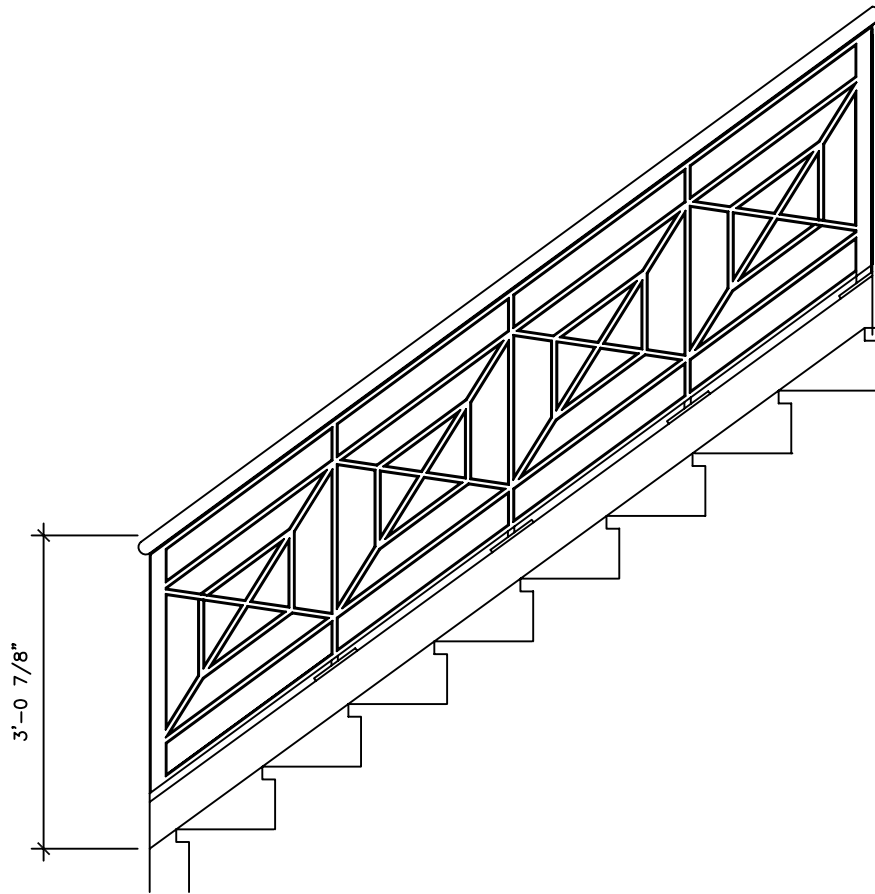

RECOMMENDED MATERIALS
IRON, ALUMINUM, BRONZE

FINISHES
PAINTED, ANTIQUED, PATINA, BRUSHED, HAND RUBBED



®

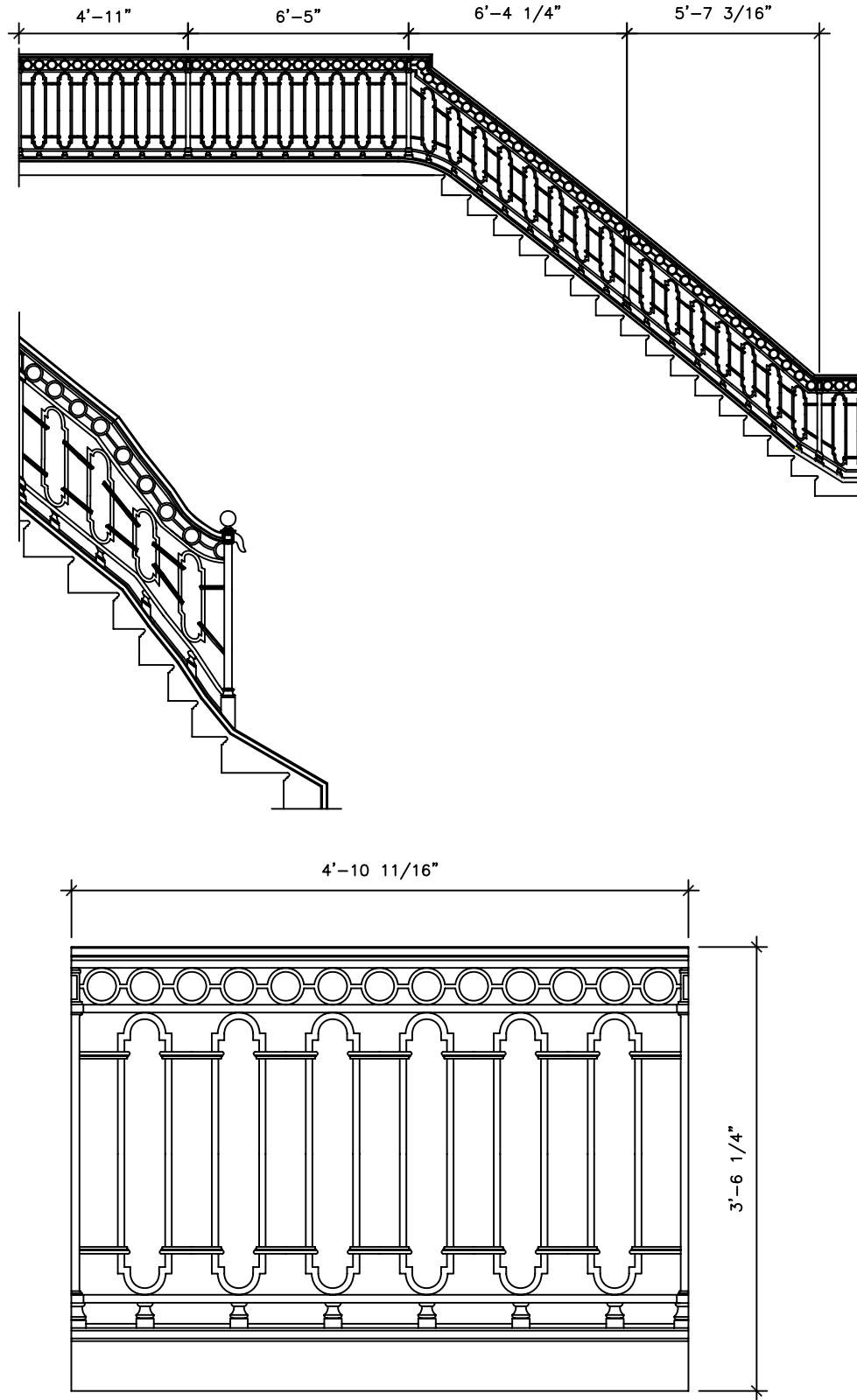

RECOMMENDED MATERIALS
ALUMINIUM, BRONZE, IRON

FINISHES
PAINTED, PATINA, BRUSHED



®

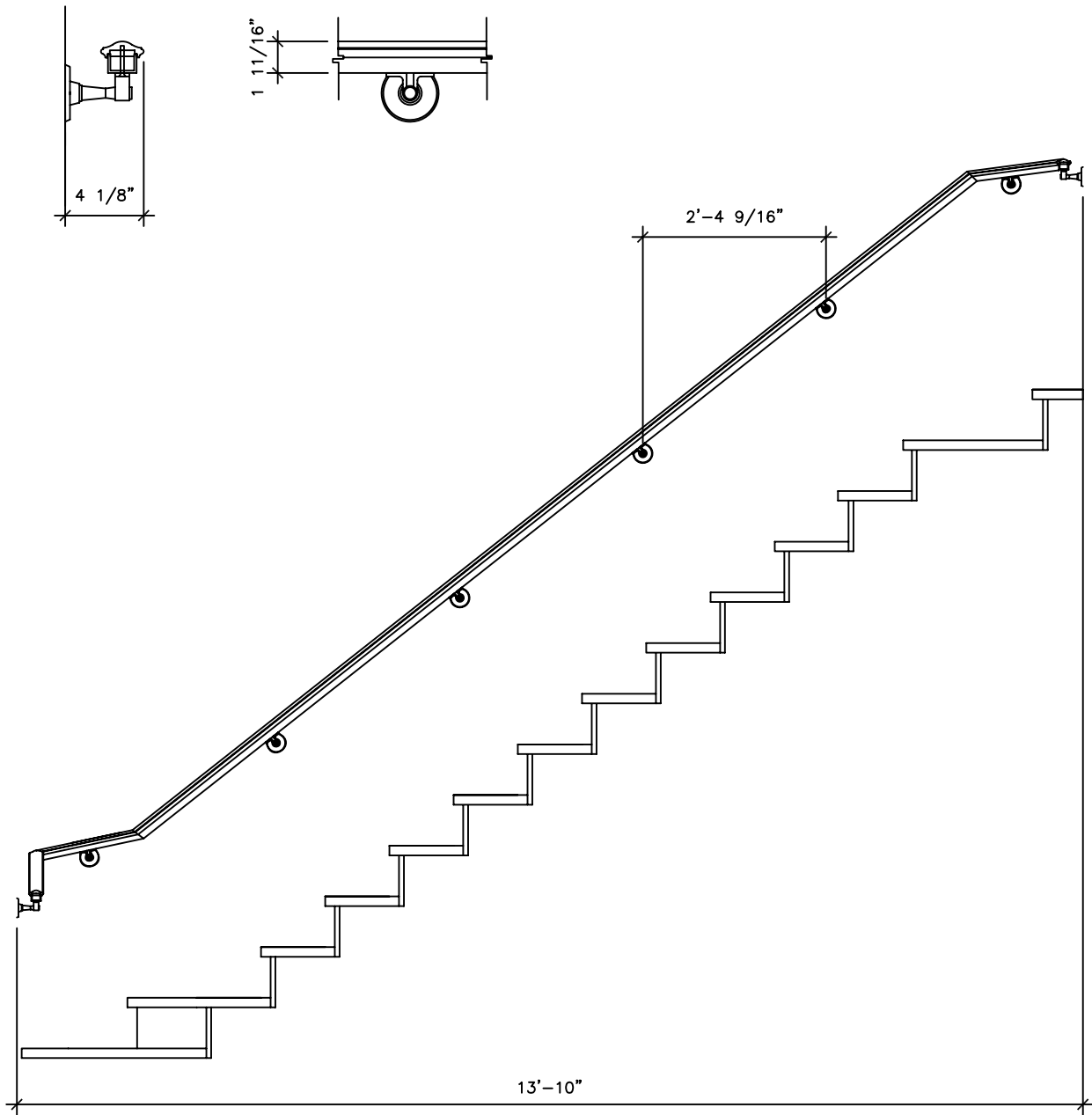

RECOMMENDED MATERIALS
IRON, ALUMINUM, BRONZE

FINISHES
PAINTED, ANTIQUED, PATINA, BRUSHED, HAND RUBBED



®

RAILING

RL069

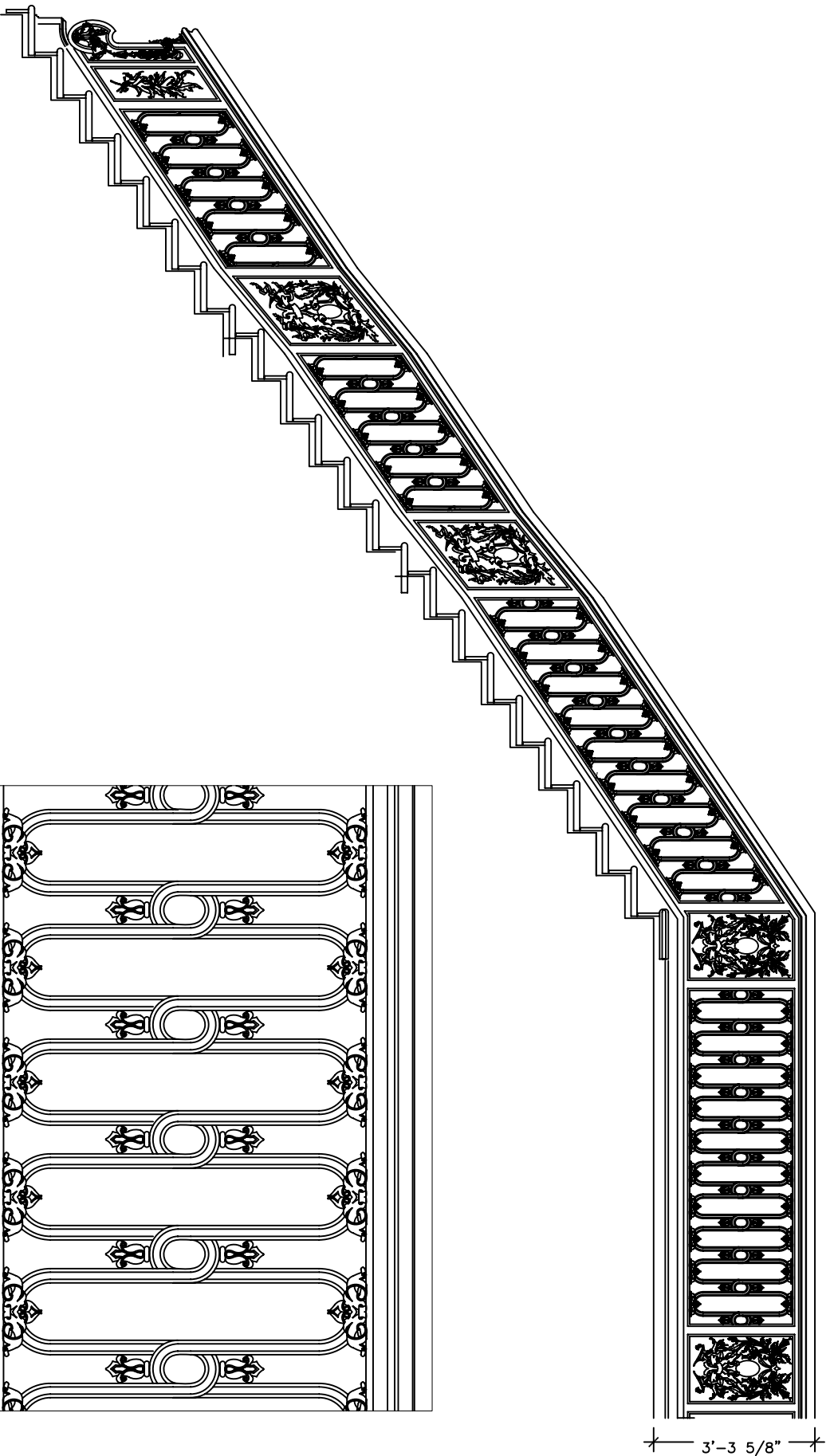

RECOMMENDED MATERIALS
IRON, ALUMINUM, BRONZE

FINISHES
PAINTED, ANTIQUED, PATINA, BRUSHED, HAND RUBBED



RAILING

RL070

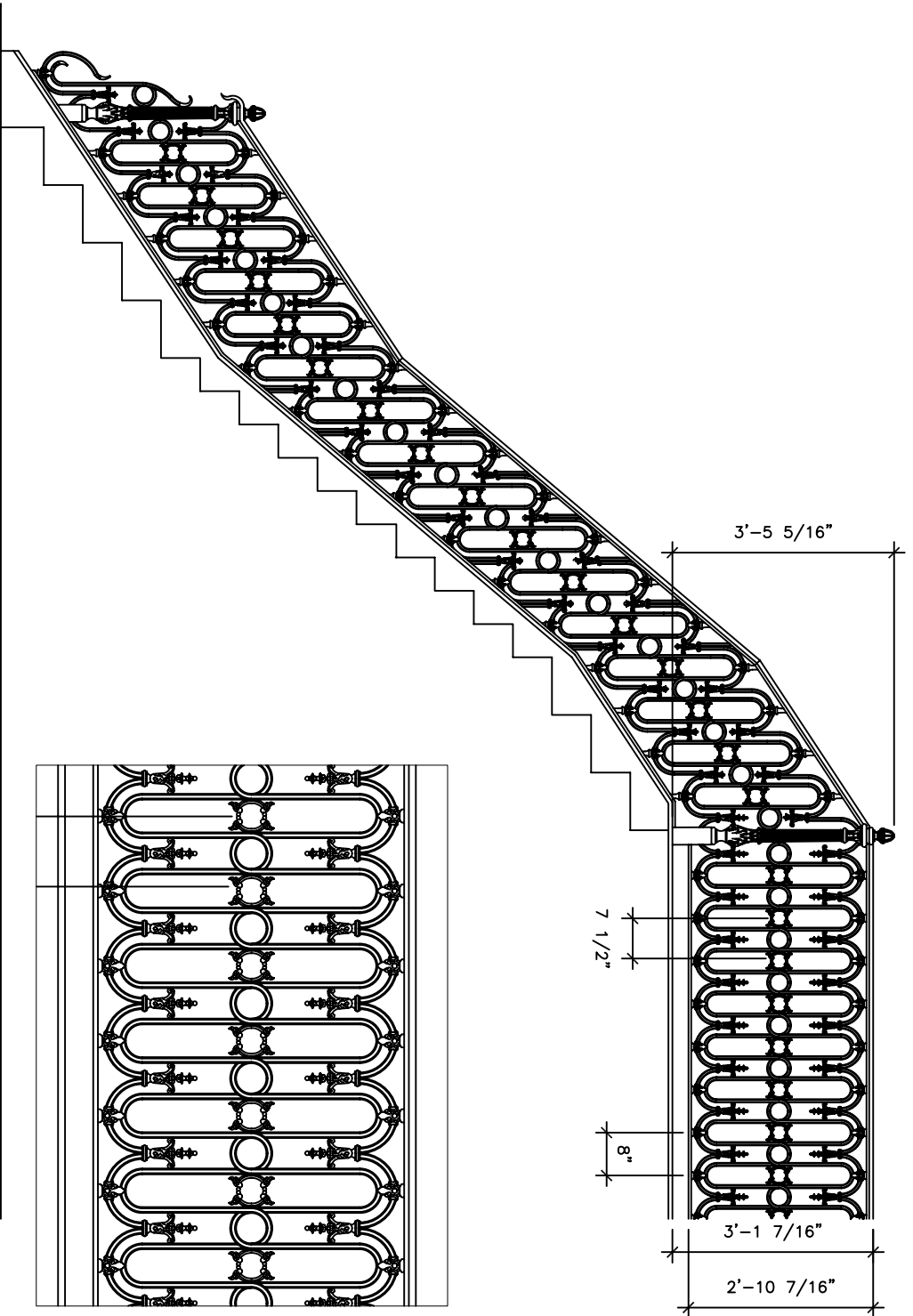

RECOMMENDED MATERIALS
IRON, ALUMINUM, BRONZE

FINISHES
PAINTED, ANTIQUED, PATINA, BRUSHED, HAND RUBBED

Design Credit:

Historical Arts & Casting, Inc. · 5580 West Bagley Park Road · West Jordan, Utah 84088 · (801) 280-2400 · www.historicalarts.com



RAILING

RL071

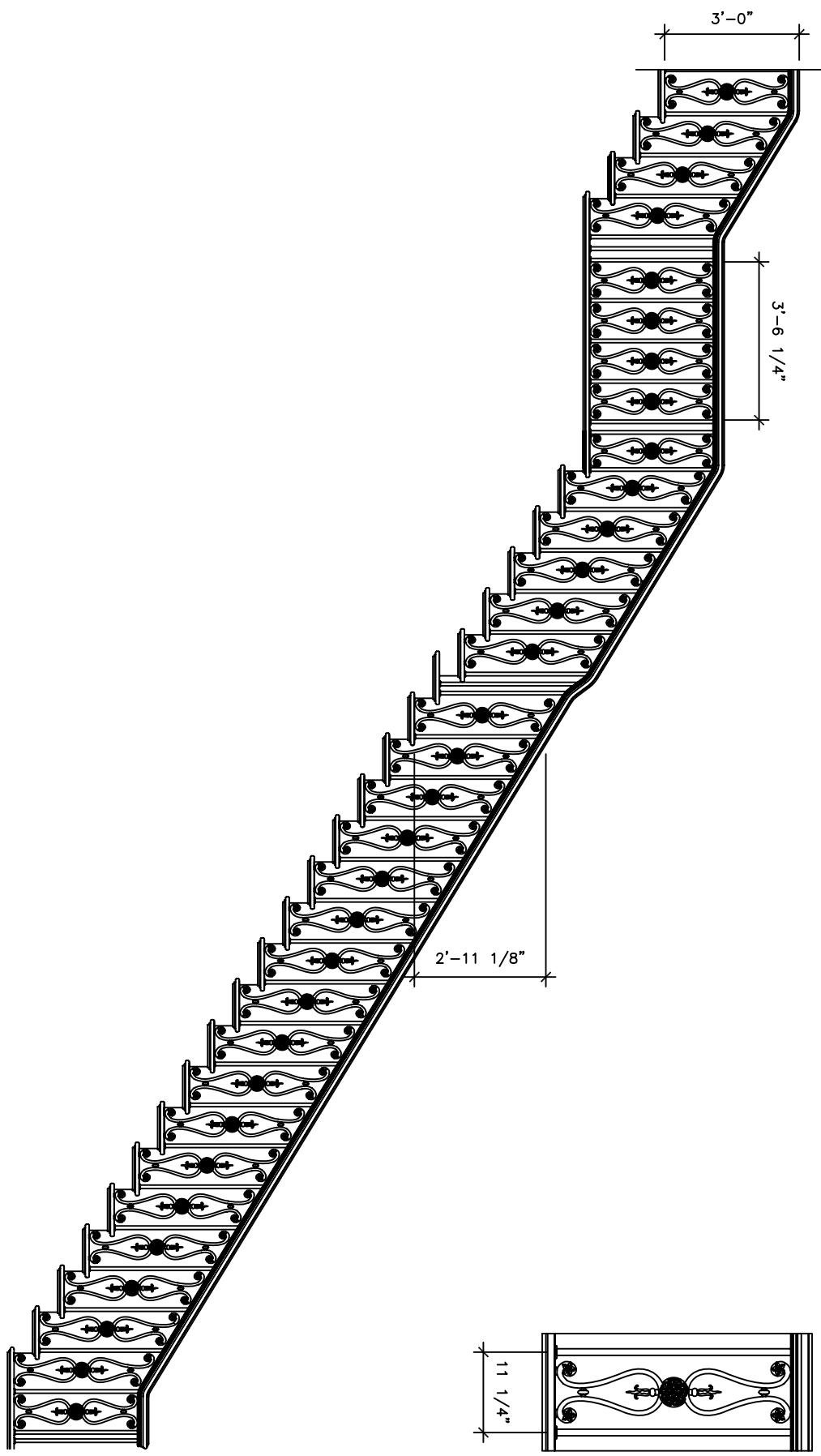

RECOMMENDED MATERIALS
IRON, ALUMINUM, BRONZE

FINISHES
PAINTED, ANTIQUED, PATINA, BRUSHED, HAND RUBBED

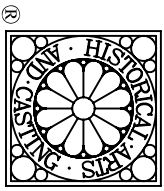

RAILING

RL072

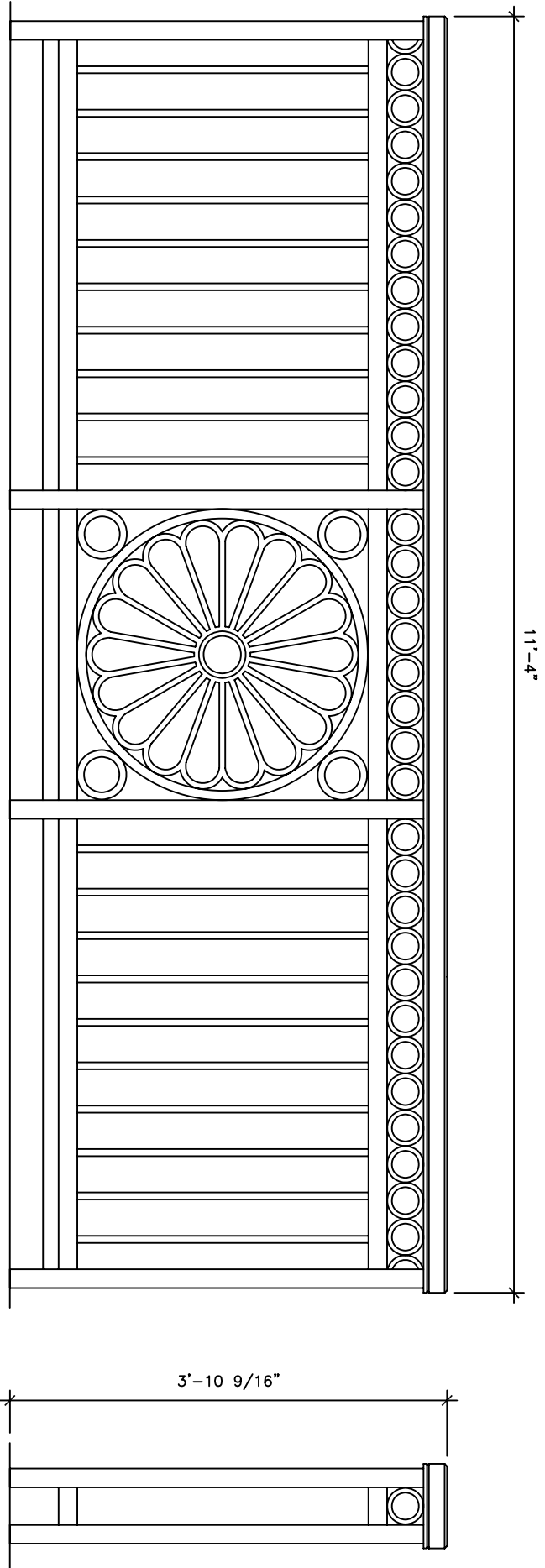

RECOMMENDED MATERIALS
IRON, ALUMINIUM, BRONZE

FINISHES
PAINTED, ANTIQUED, PATINA, BRUSHED, HAND RUBBED

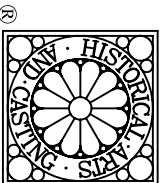

Design Credit:

Historical Arts & Casting, Inc. · 5580 West Bagley Park Road · West Jordan, Utah 84088 · (801) 280-2400 · www.historicalarts.com

RAILING

RL073

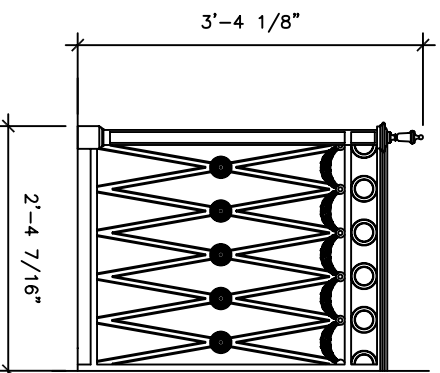
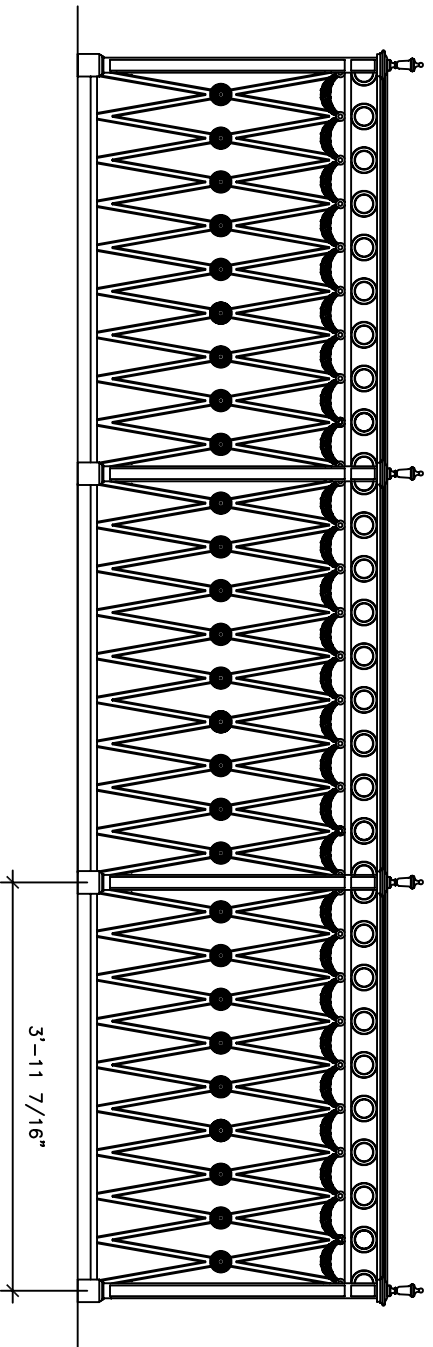
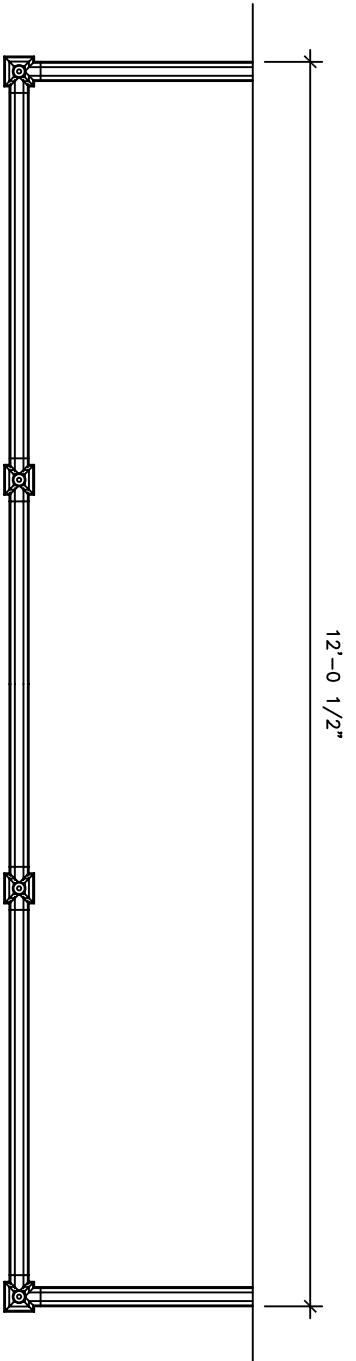

RECOMMENDED MATERIALS
IRON, ALUMINUM, BRONZE

FINISHES
PAINTED, ANTIQUED, PATINA, BRUSHED, HAND RUBBED



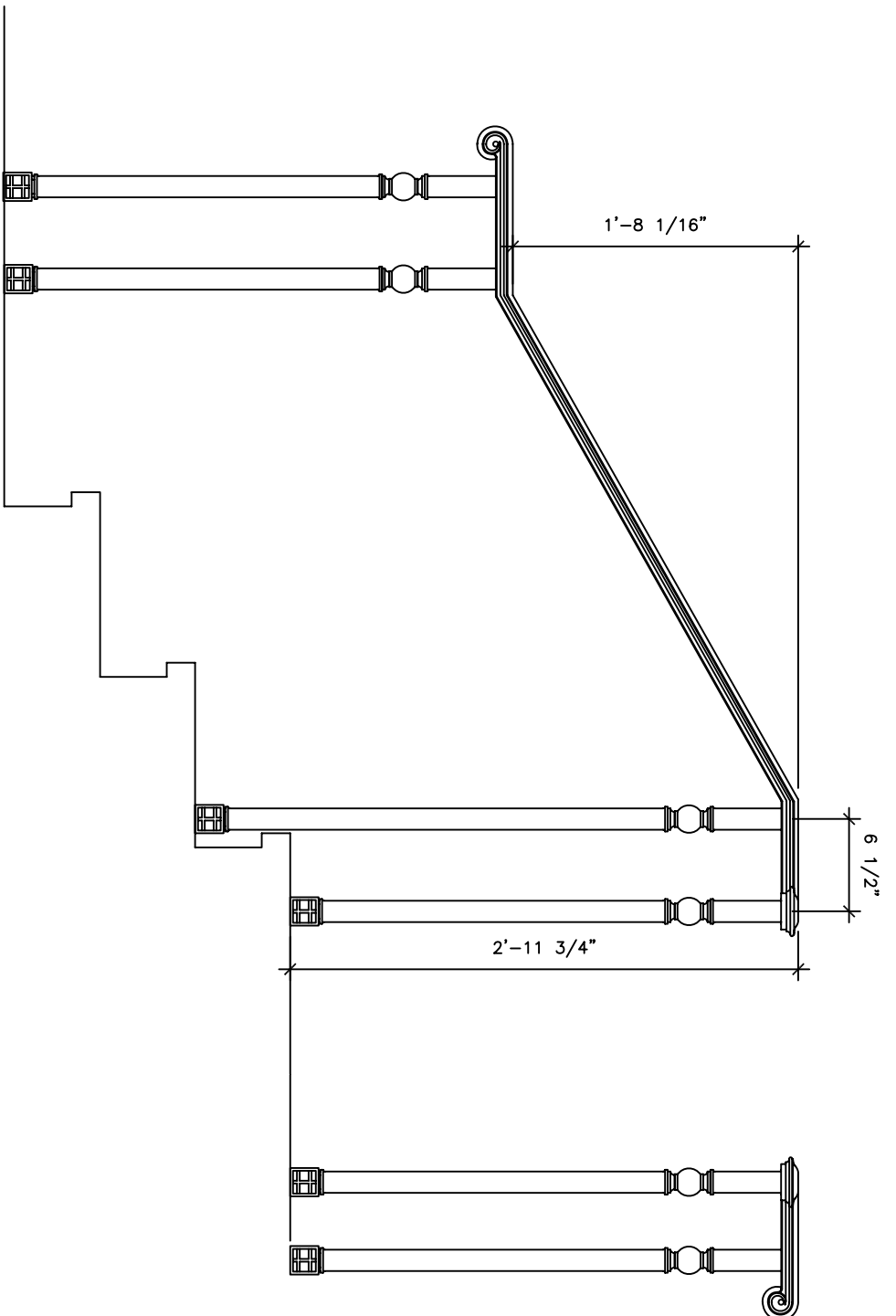

RECOMMENDED MATERIALS FINISHES
IRON, ALUMINUM, BRONZE PAINTED, ANTIQUED, PATINA, BRUSHED, HAND RUBBED

Design Credit:

Historical Arts & Casting, Inc. · 5580 West Bagley Park Road · West Jordan, Utah 84088 · (801) 280-2400 · www.historicalarts.com

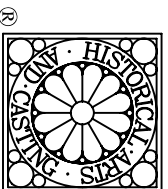

RAILING

RL075

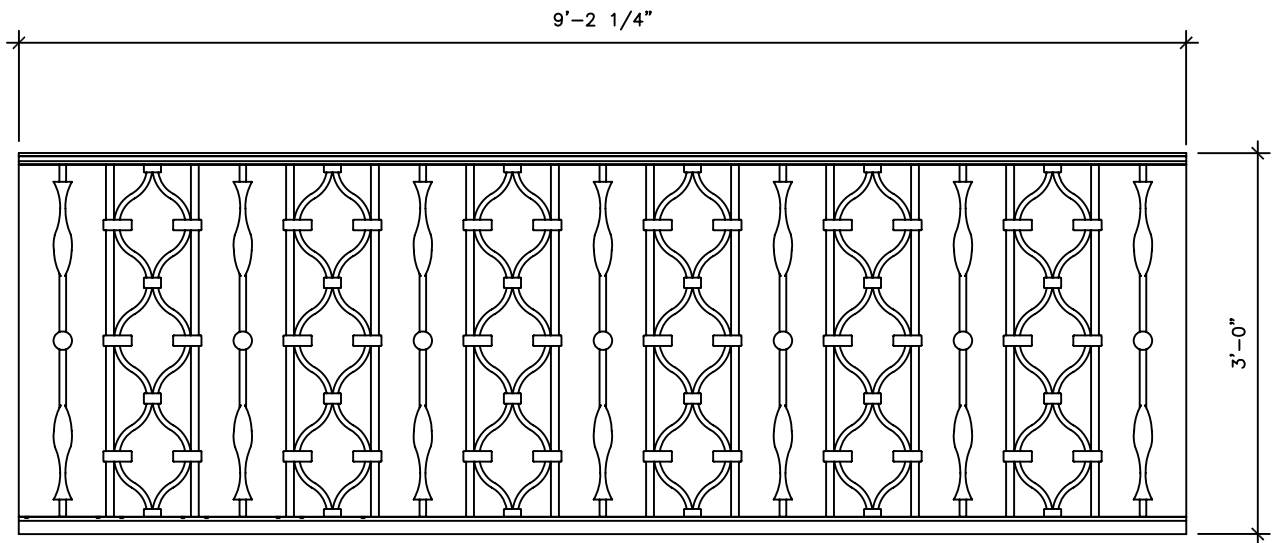
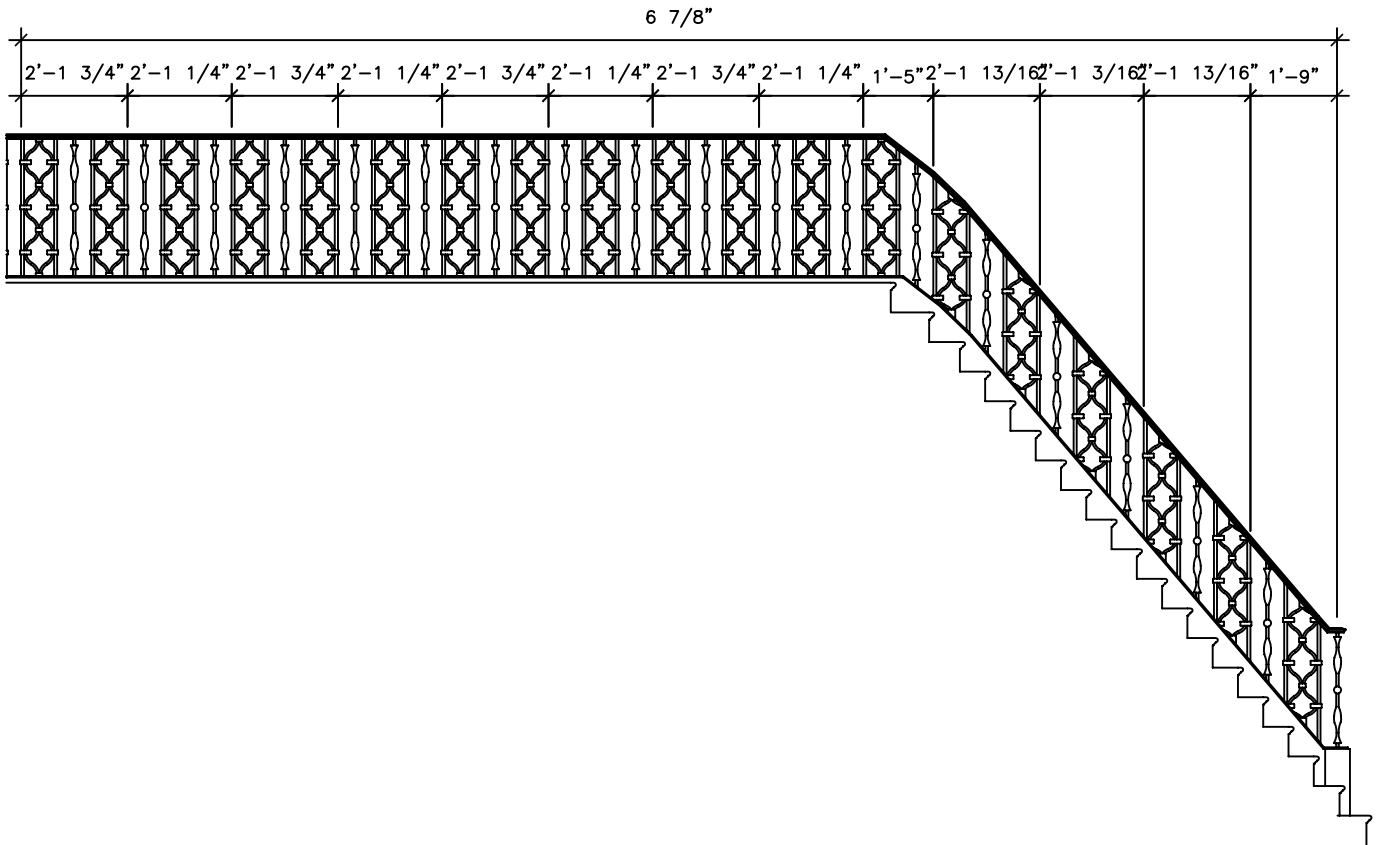

RECOMMENDED MATERIALS
ALUMINIUM, BRONZE, IRON

FINISHES
PAINTED, PATINA, BRUSHED



®

RAILING

RL076

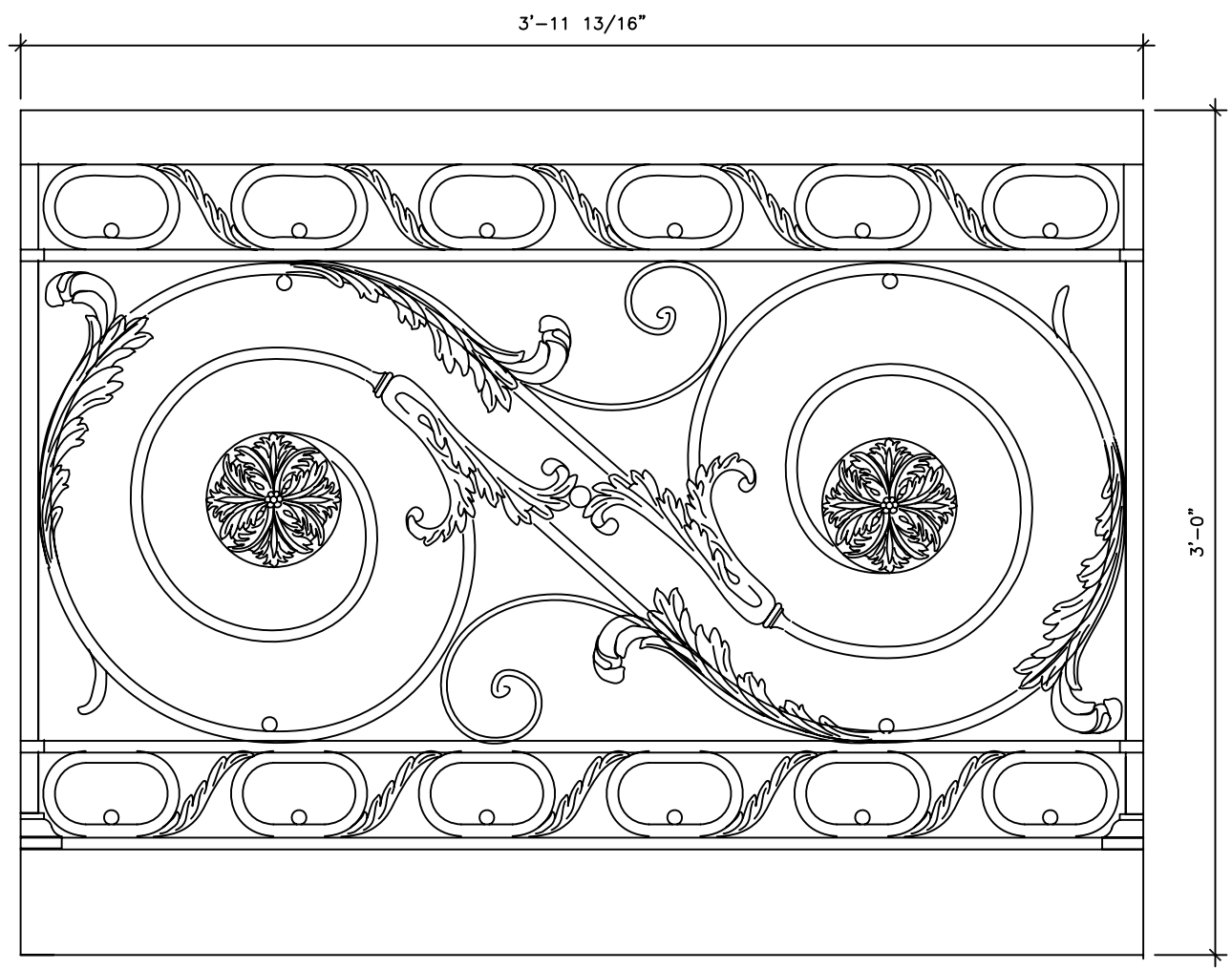
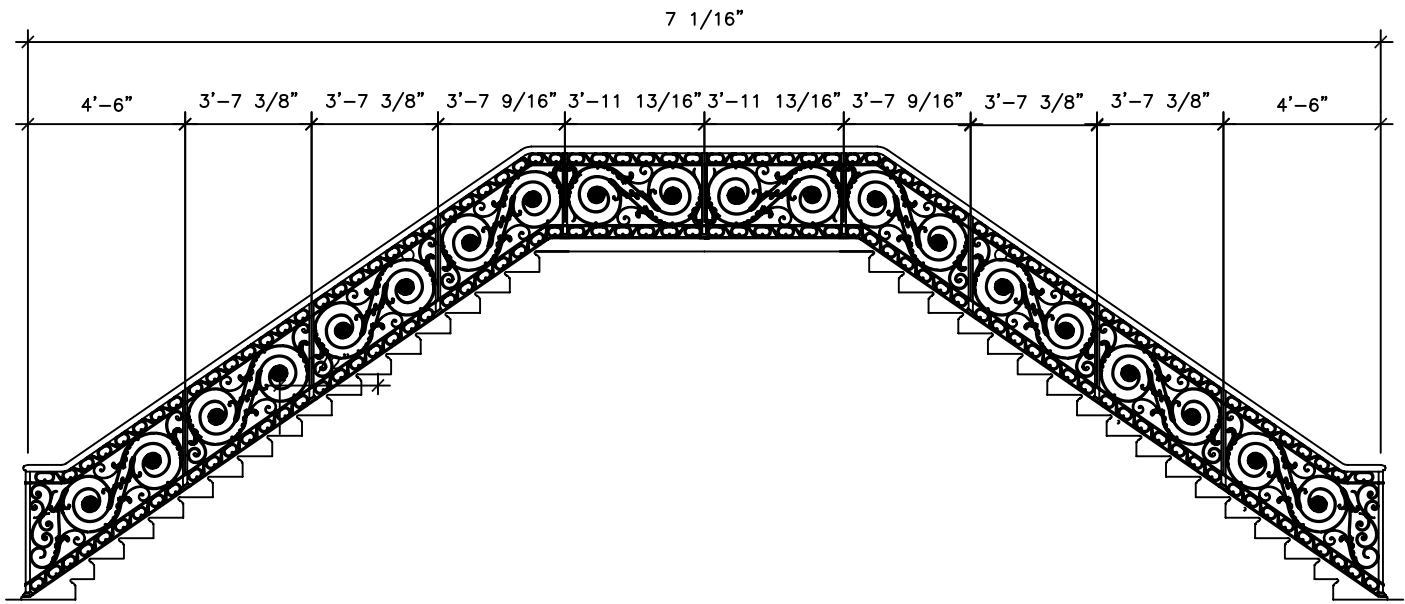

RECOMMENDED MATERIALS
ALUMINIUM, BRONZE, IRON

FINISHES
PAINTED, PATINA, BRUSHED



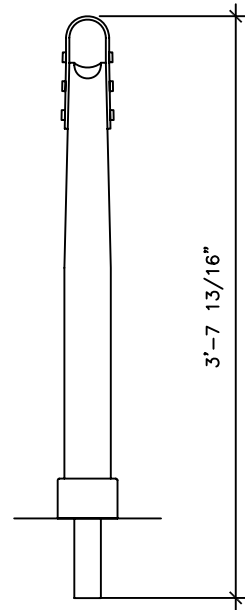
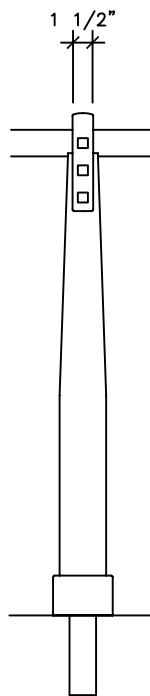
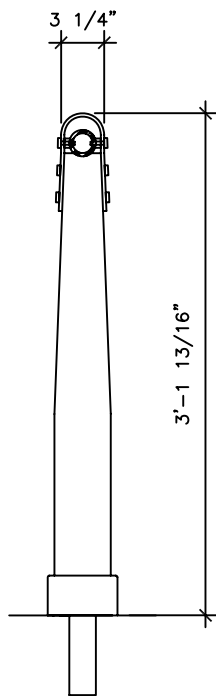
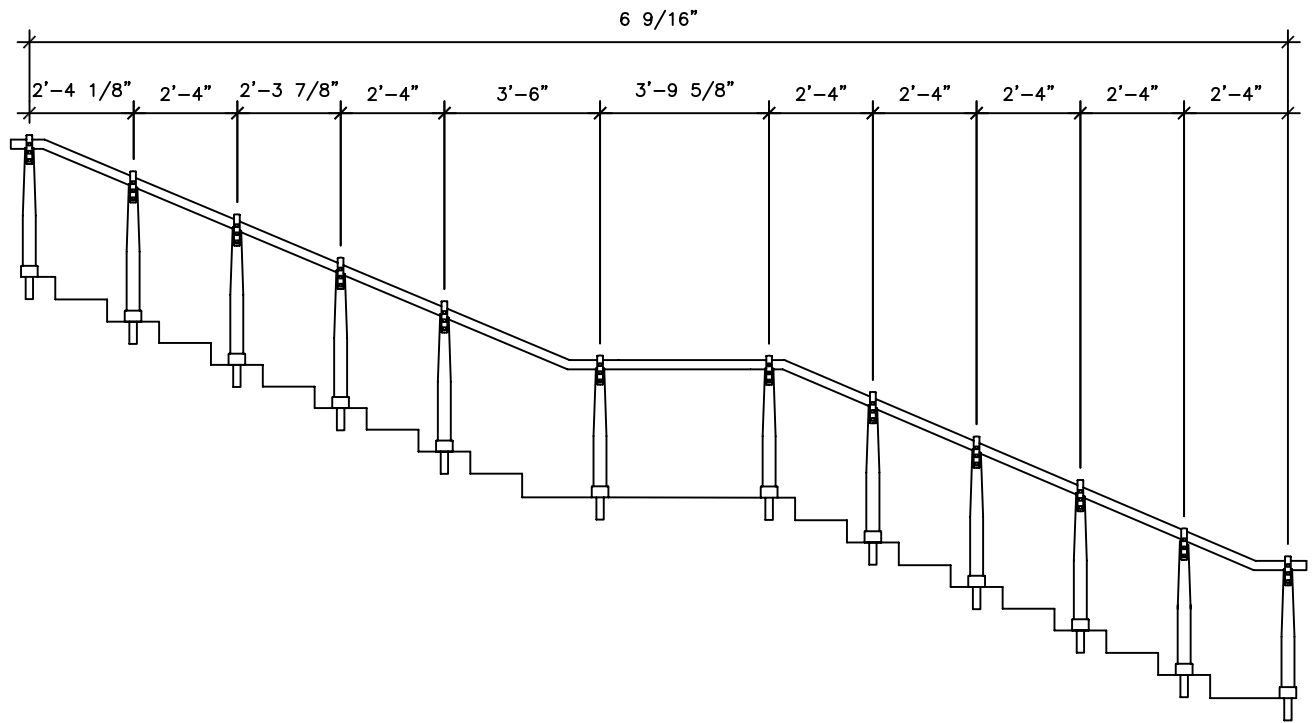

RECOMMENDED MATERIALS
ALUMINIUM, BRONZE, IRON

FINISHES
PAINTED, PATINA, BRUSHED



®

RAILING

RL078

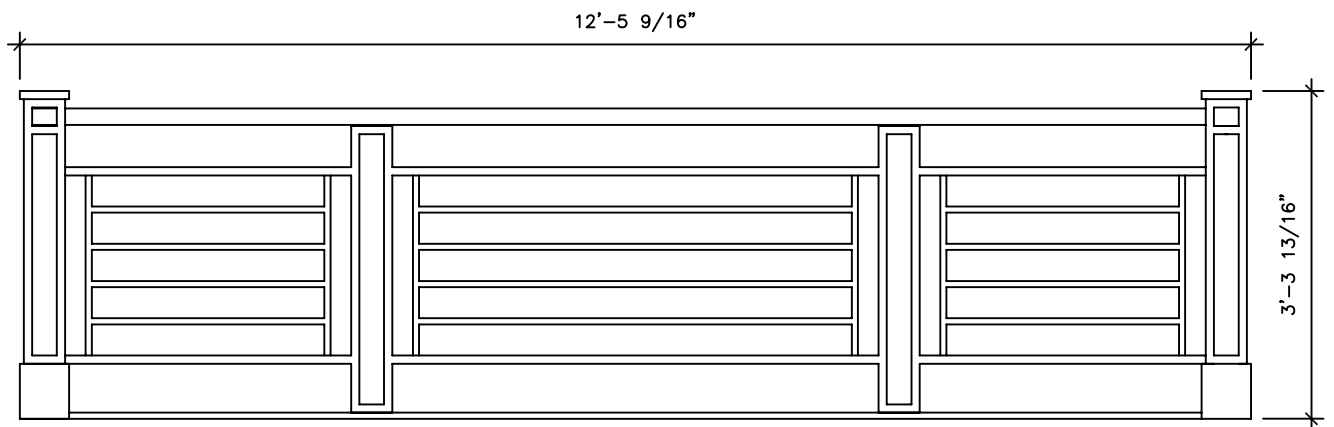
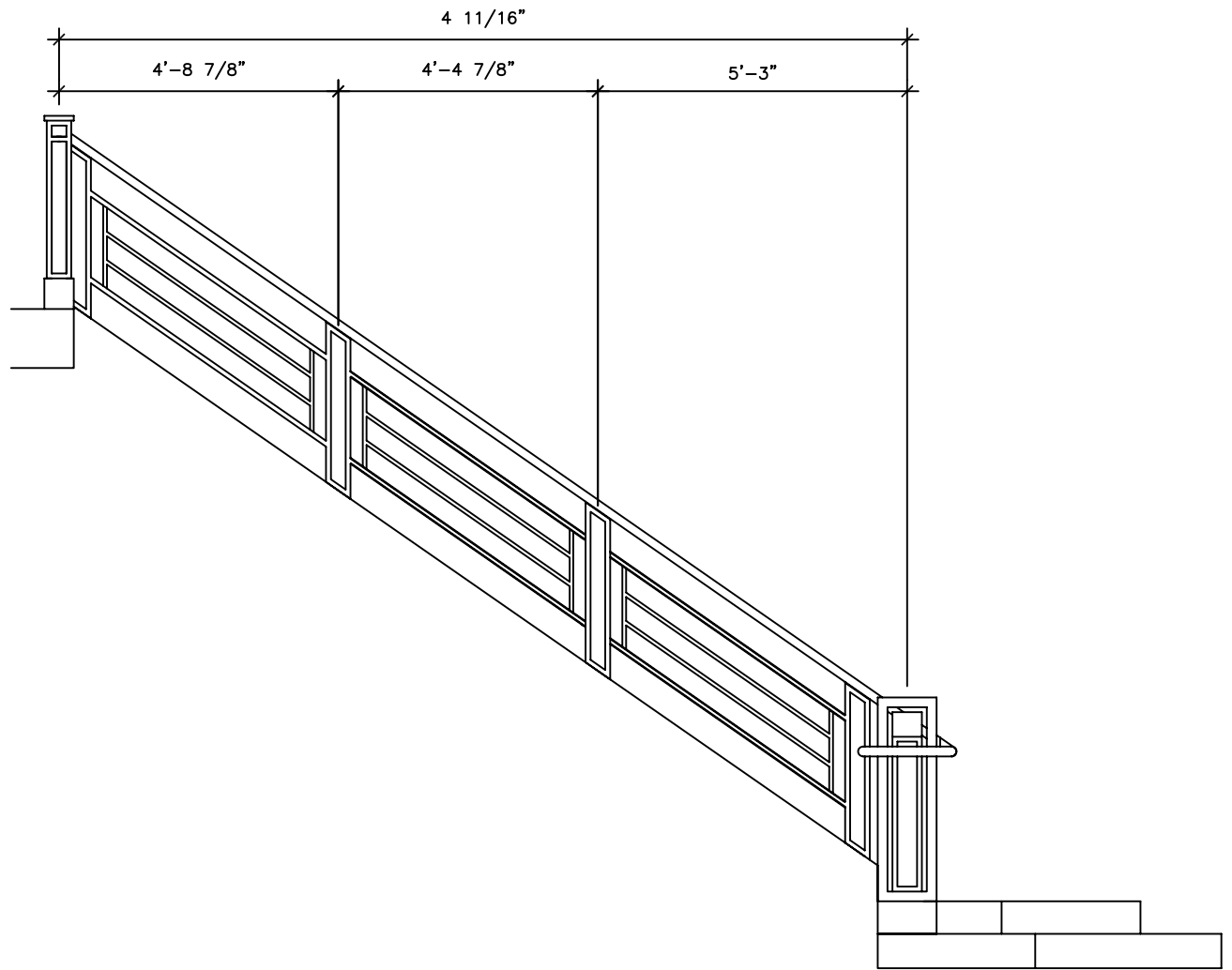

RECOMMENDED MATERIALS
ALUMINIUM, BRONZE, IRON

FINISHES
PAINTED, PATINA, BRUSHED



®

RAILING

RL079

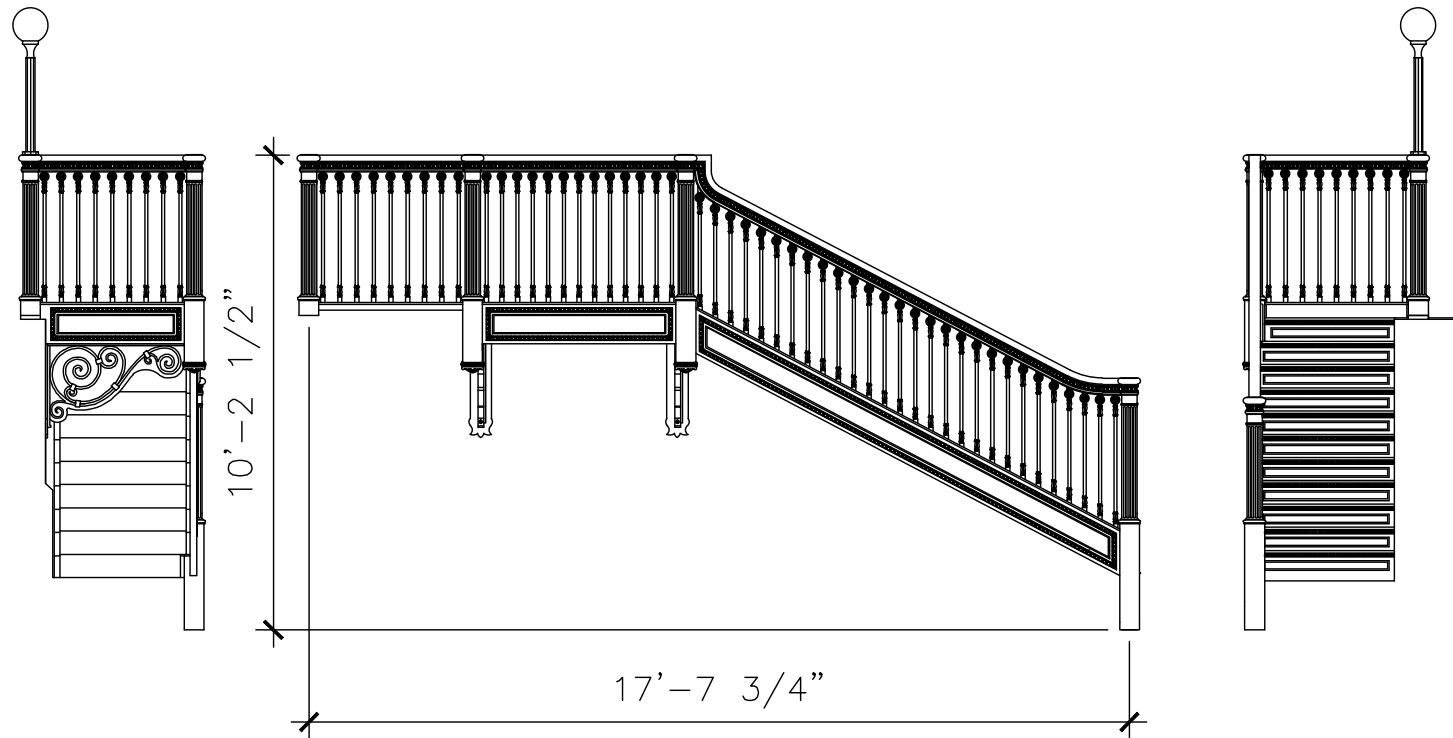

RECOMMENDED MATERIALS

IRON, ALUMINUM, BRONZE

FINISHES

PAINTEG, ANTIQUED, PATINA, BRUSHED, HAND RUBBED



RAILING

RL080

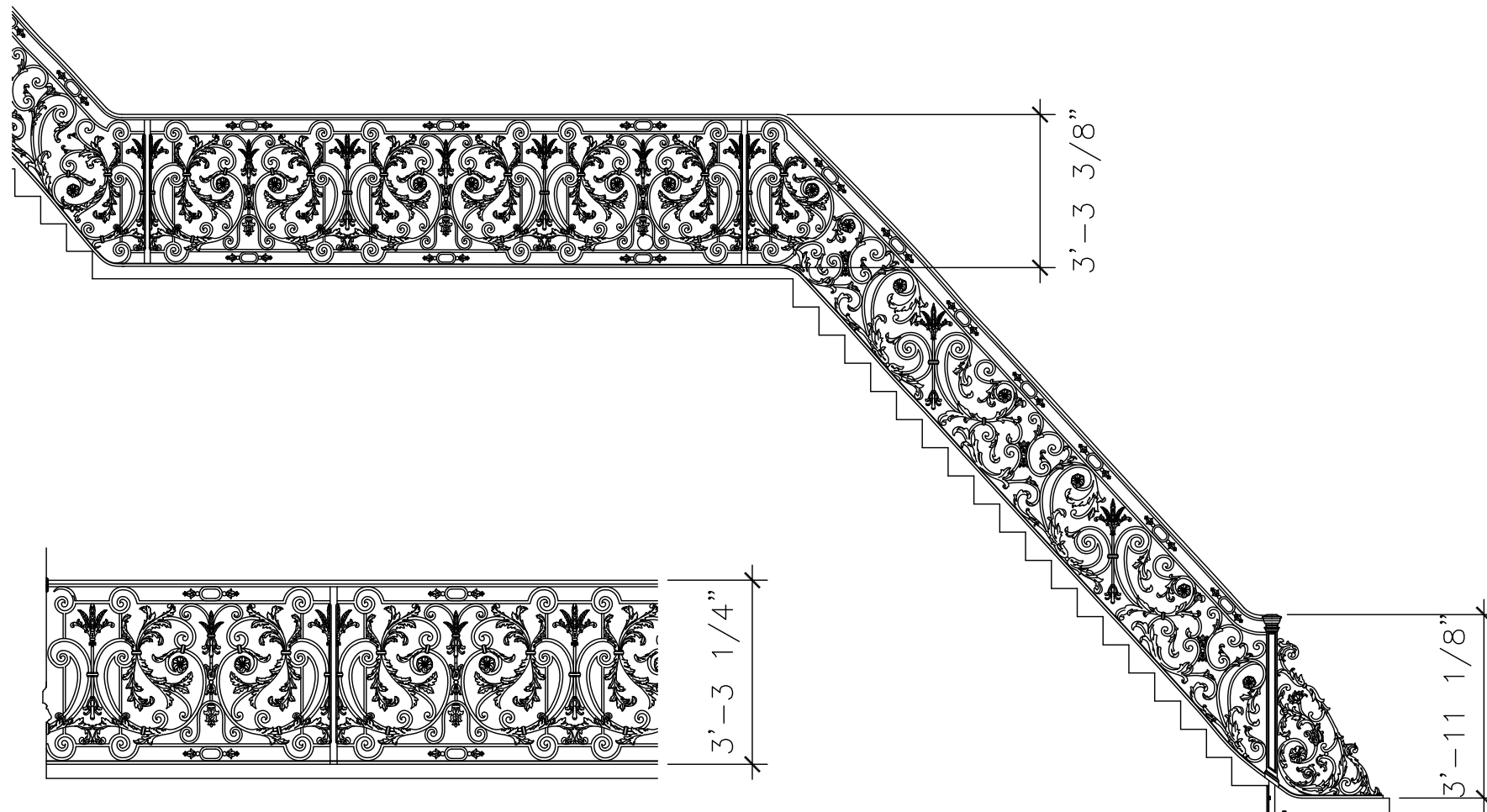

RECOMMENDED MATERIALS

IRON, ALUMINUM, BRONZE

FINISHES

PAINTED, ANTIQUED, PATINA, BRUSHED, HAND RUBBED



RAILING

RL081

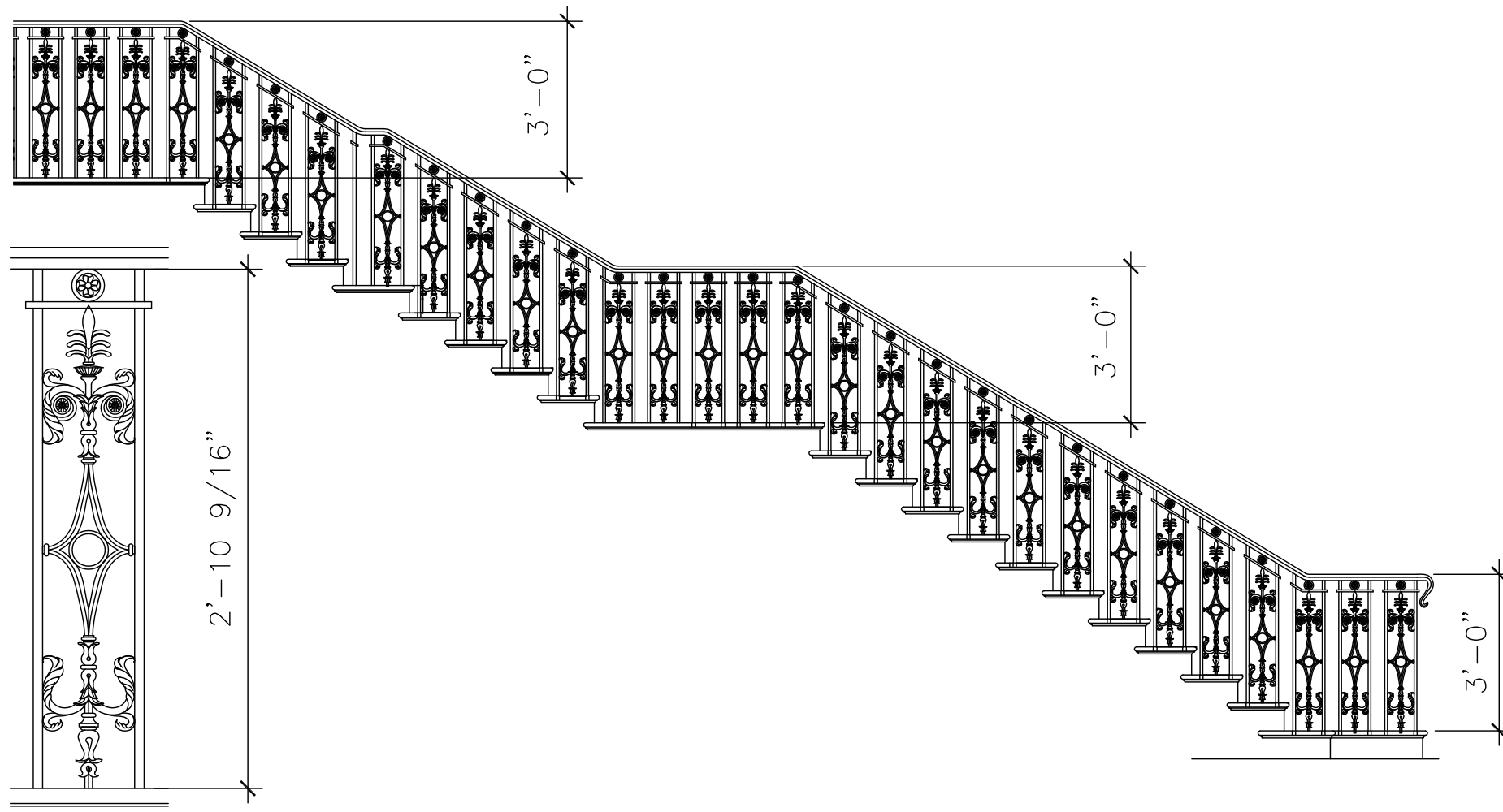

RECOMMENDED MATERIALS

IRON, ALUMINUM, BRONZE

FINISHES

PAINTED, ANTIQUED, PATINA, BRUSHED, HAND RUBBED



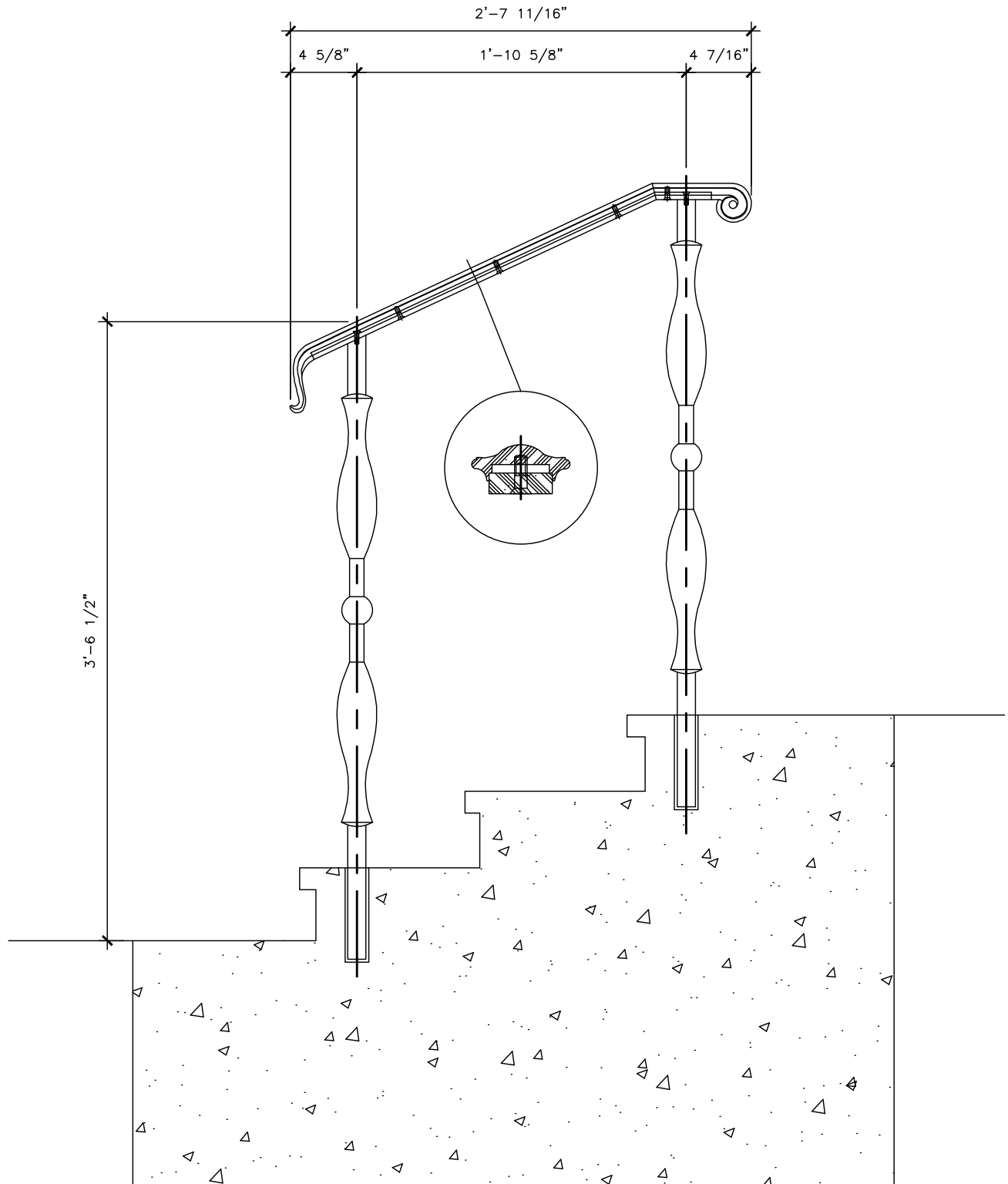

RECOMMENDED MATERIALS
ALUMINIUM, BRONZE, IRON

FINISHES
PAINTED, PATINA, BRUSHED



RAILING

RL083

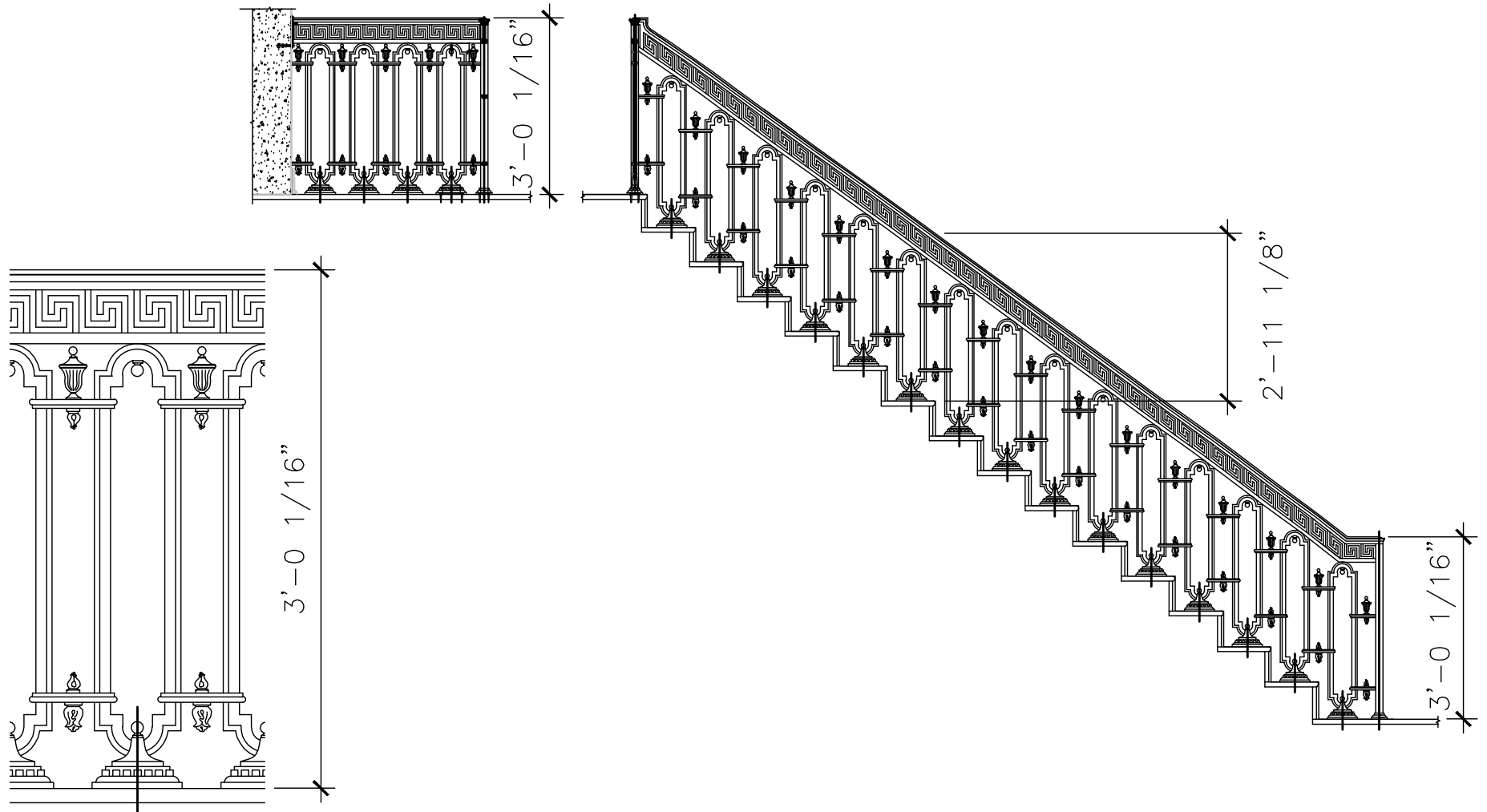

RECOMMENDED MATERIALS

IRON, ALUMINUM, BRONZE

FINISHES

PAINTEG, ANTIQUEG, PATINA, BRUSHED, HAND RUBBED



RAILING

RL084

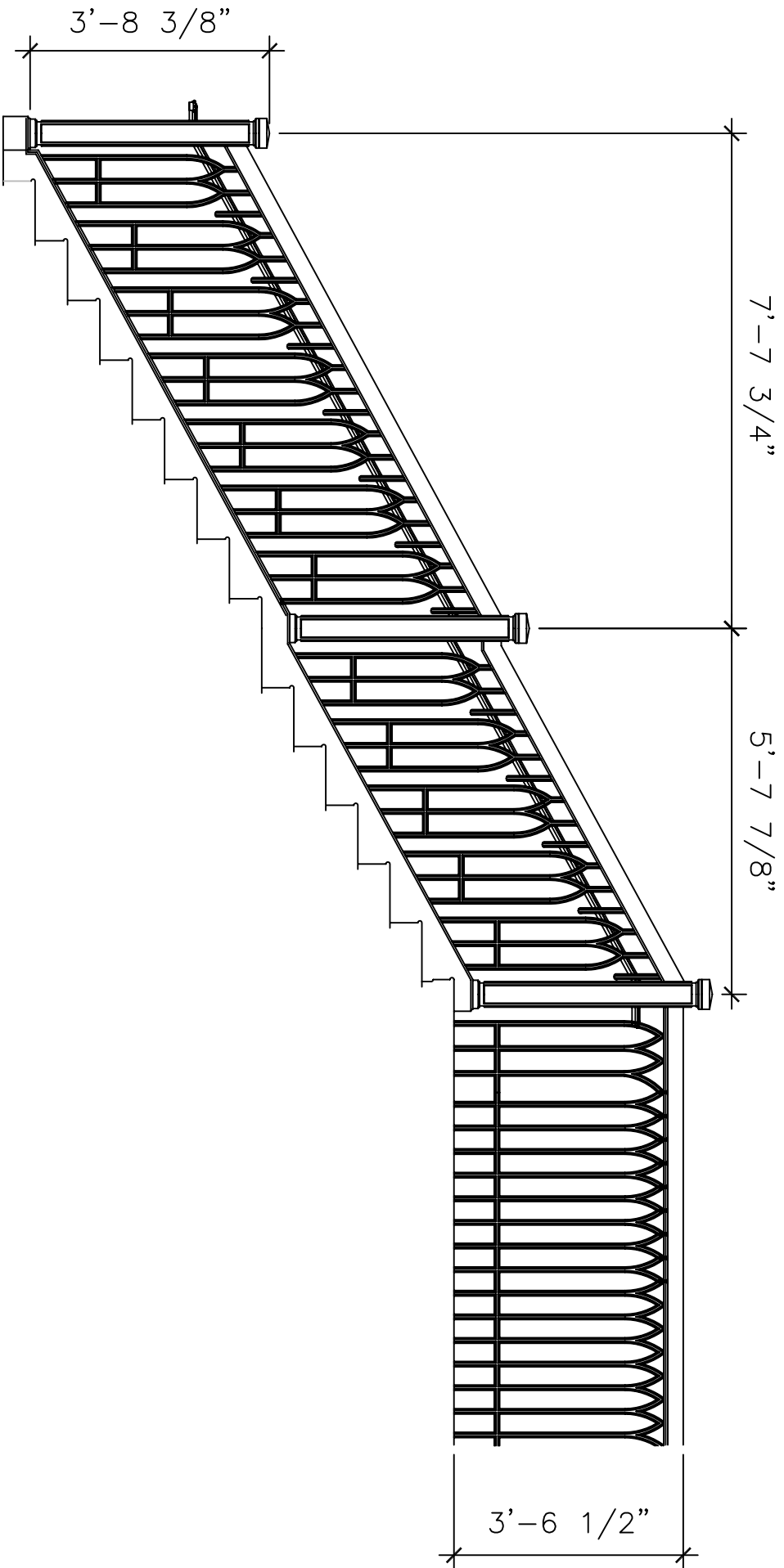

RECOMMENDED MATERIALS
ALUMINUM, BRONZE

FINISHES
PAINTED, ANTIQUED, PATINA, BRUSHED, HAND RUBBED



RAILING

RL085

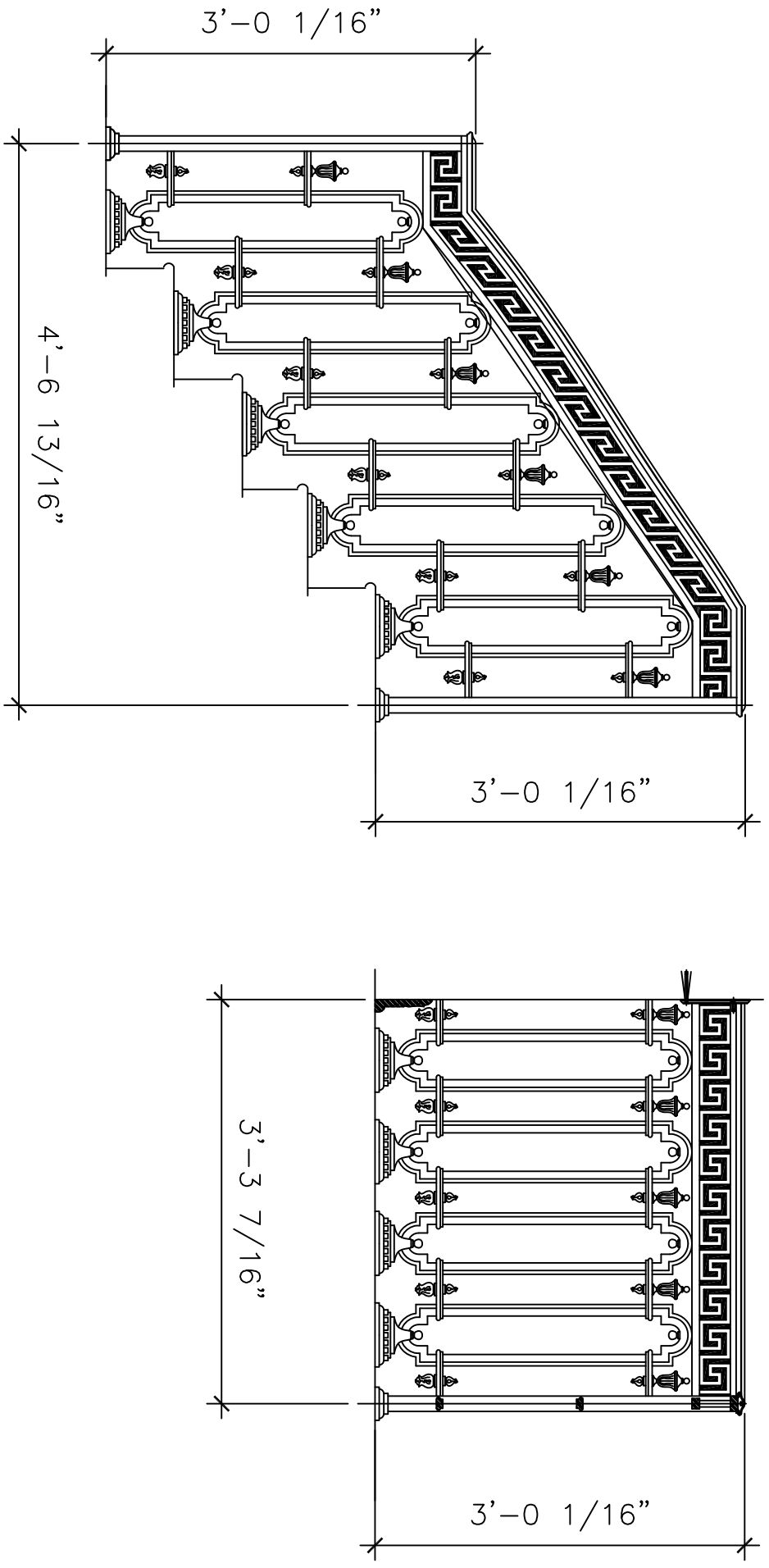

RECOMMENDED MATERIALS
ALUMINUM, BRONZE

FINISHES
PAINTED, ANTIQUED, PATINA, BRUSHED, HAND RUBBED



RAILING

RL086

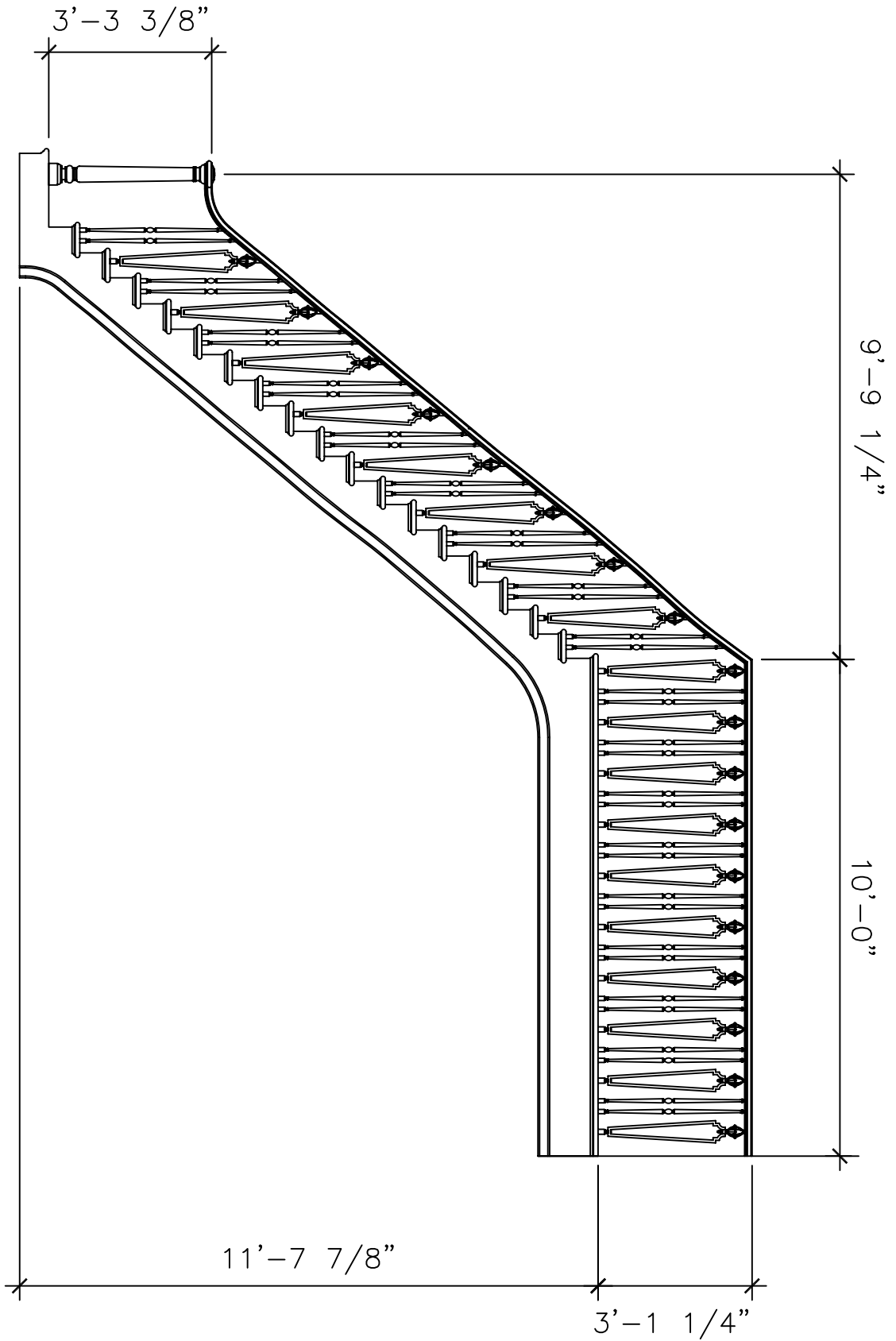

RECOMMENDED MATERIALS
ALUMINUM, BRONZE

FINISHES
PAINTED, ANTIQUED, PATINA, BRUSHED, HAND RUBBED



RAILING

RL087

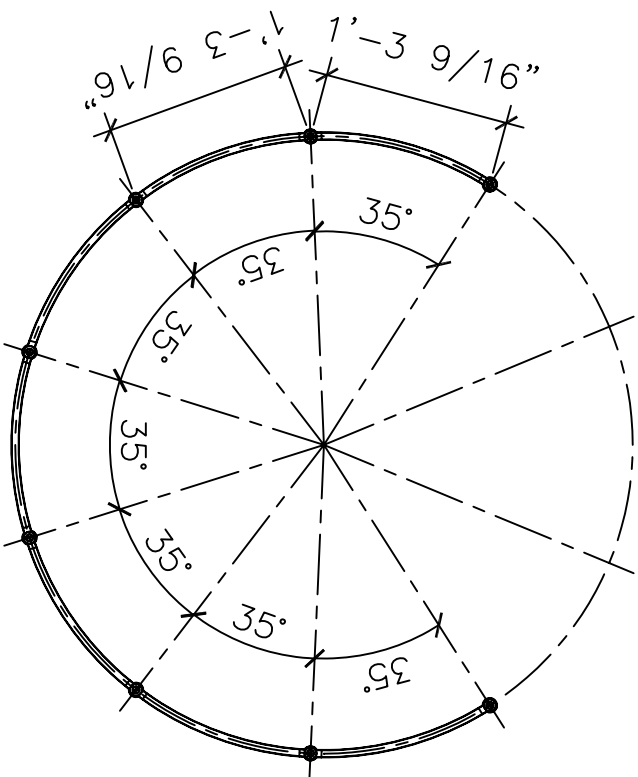
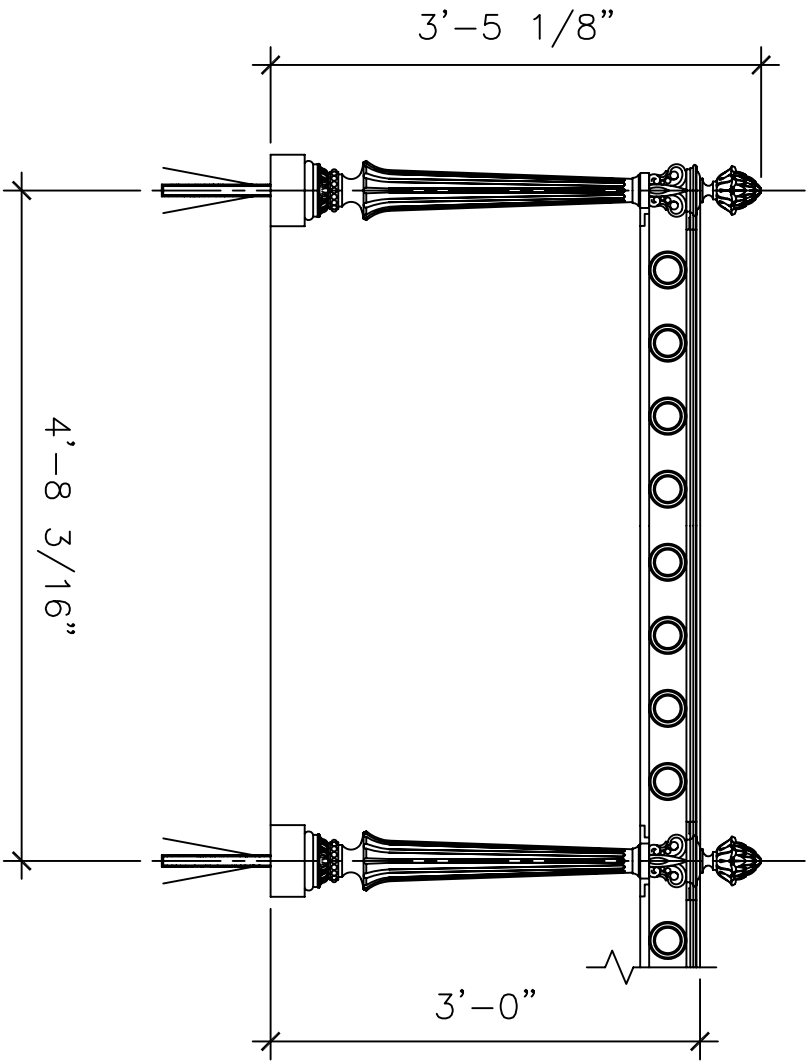

RECOMMENDED MATERIALS
ALUMINUM, BRONZE

FINISHES
PAINTED, ANTIQUED, PATINA, BRUSHED, HAND RUBBED

